

3D CAD

Elia Schoen



Microsoft 3D Builder



Microsoft 3D Builder

3D Builder Interface

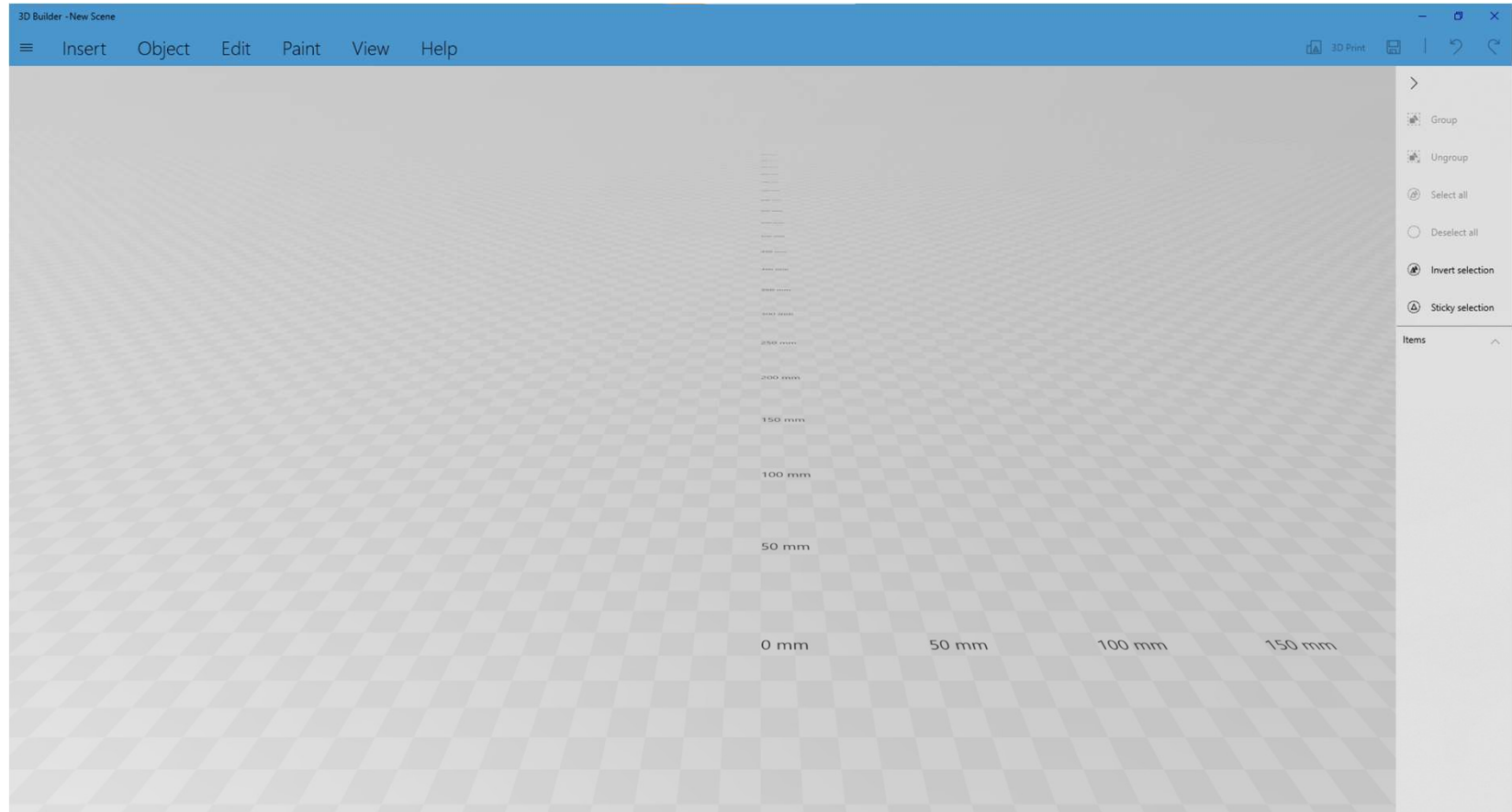



Microsoft 3D Builder

3D Builder Interface

3D Builder - New Scene



Insert

Object

Edit

Paint

View

Help

Command Row





Microsoft 3D Builder

3D Builder Interface

Command Row

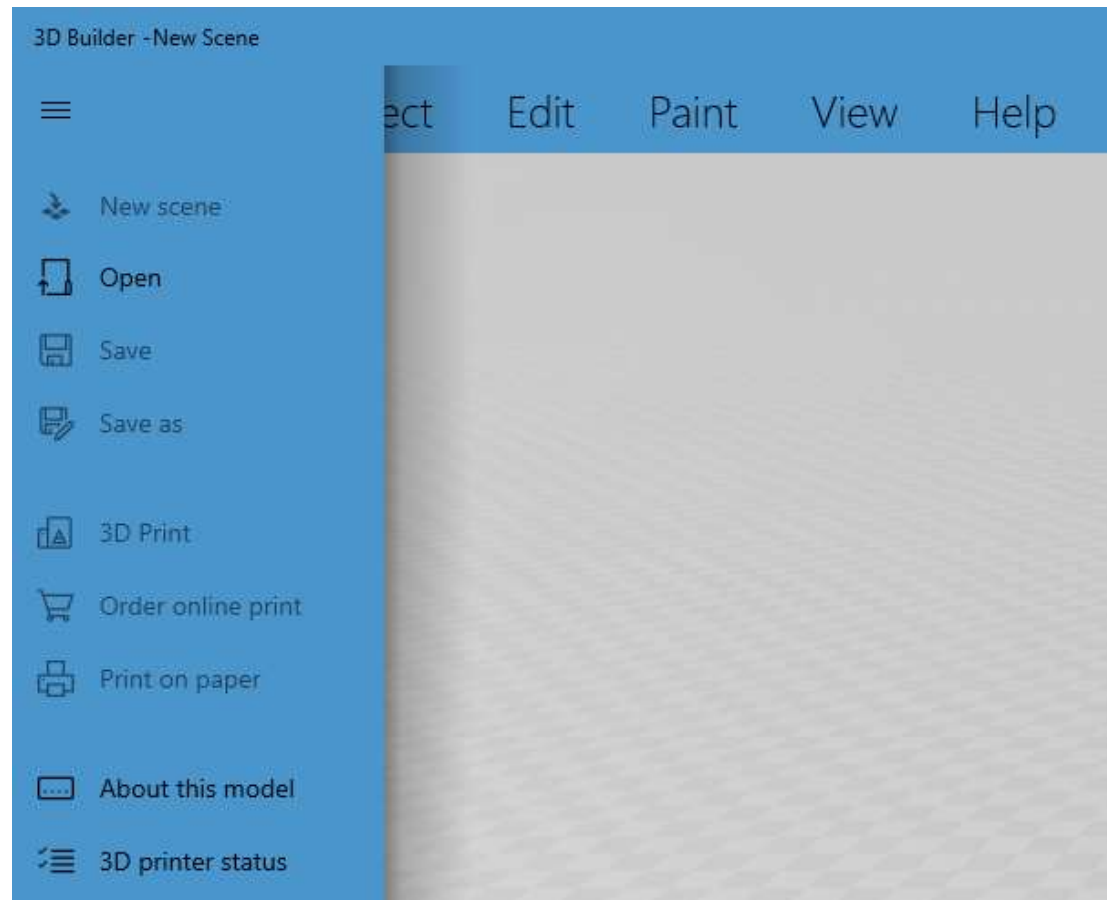



Microsoft 3D Builder

3D Builder Interface

Command Row
ADD

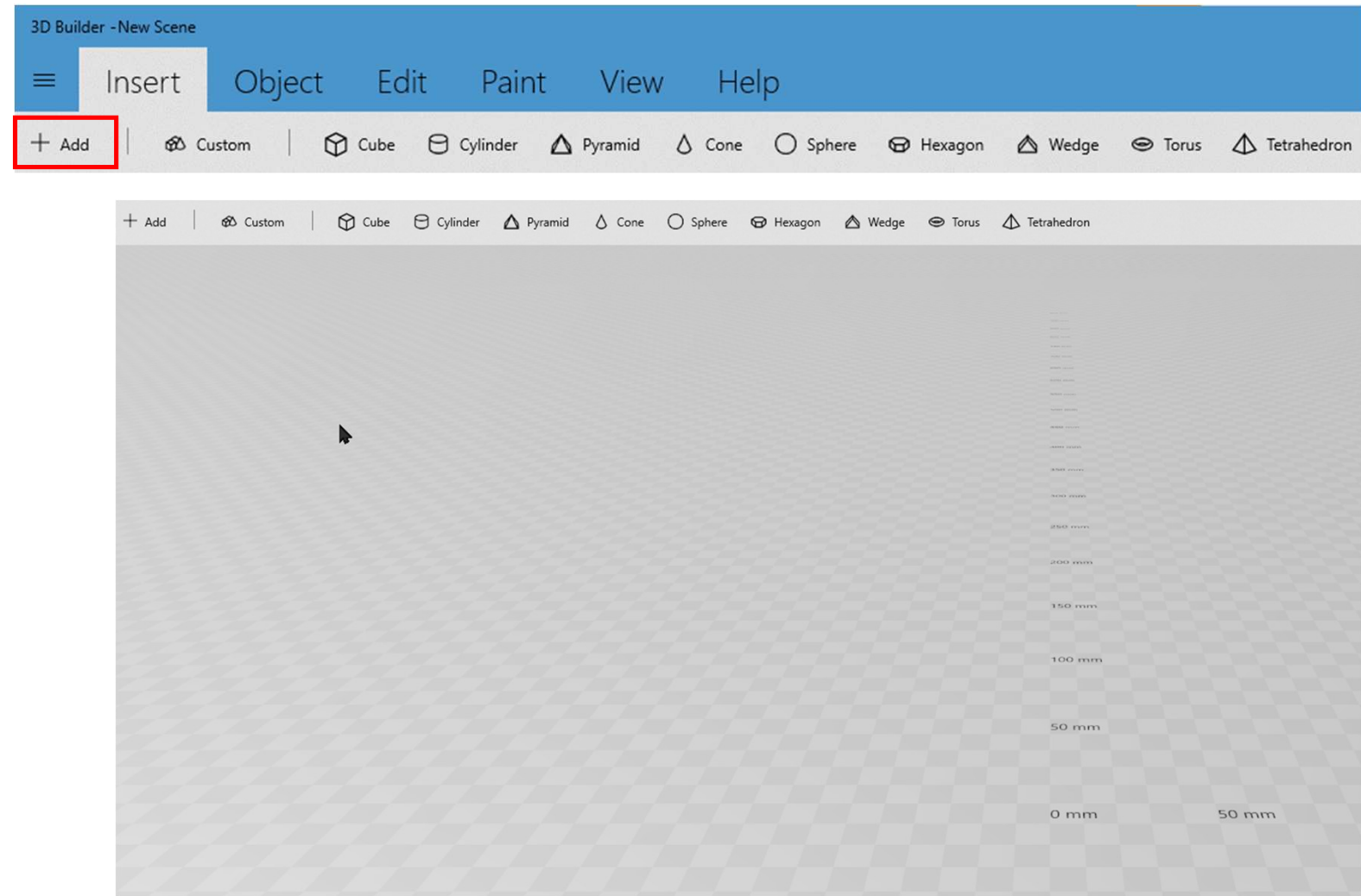



Microsoft 3D Builder

3D Builder Interface

Command Row CUSTOM

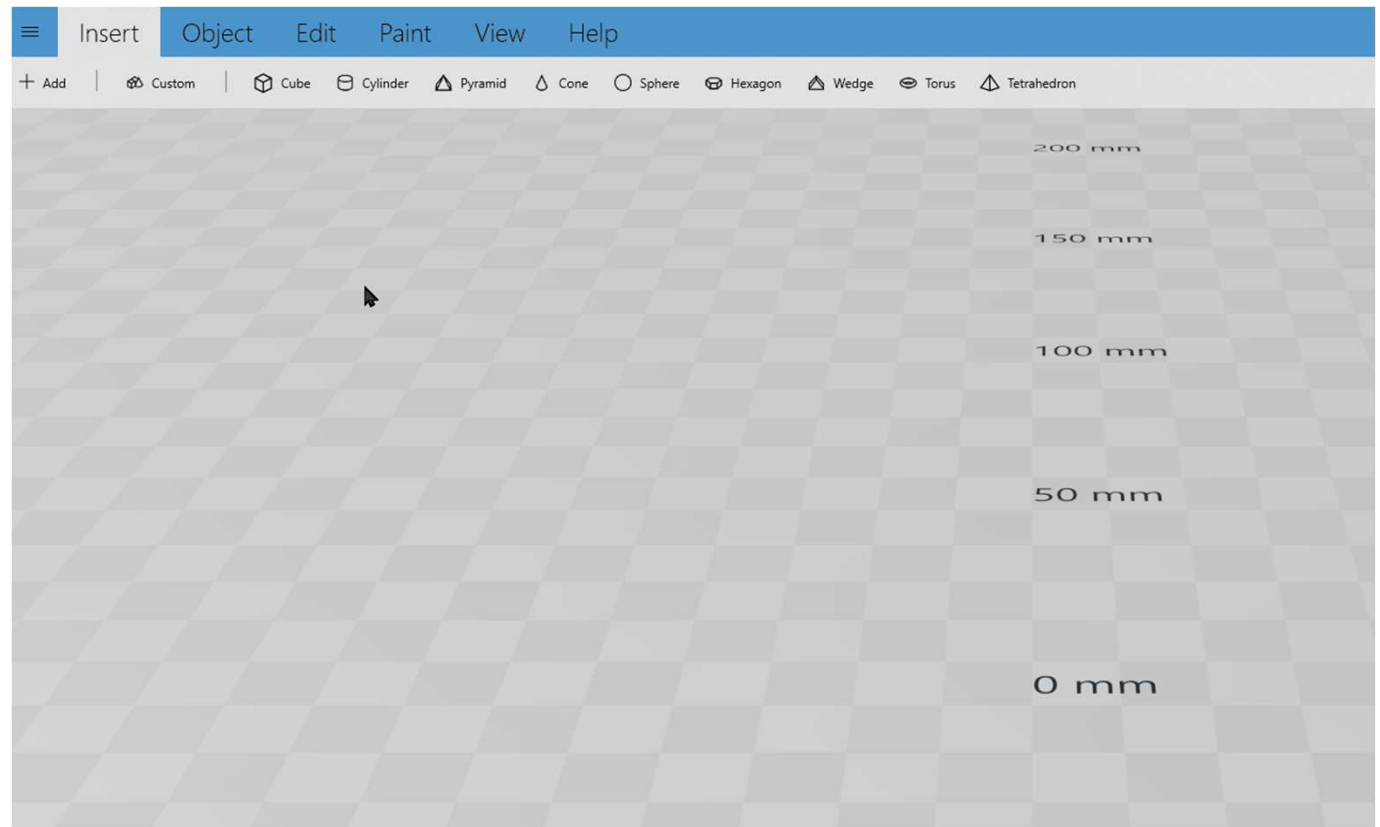
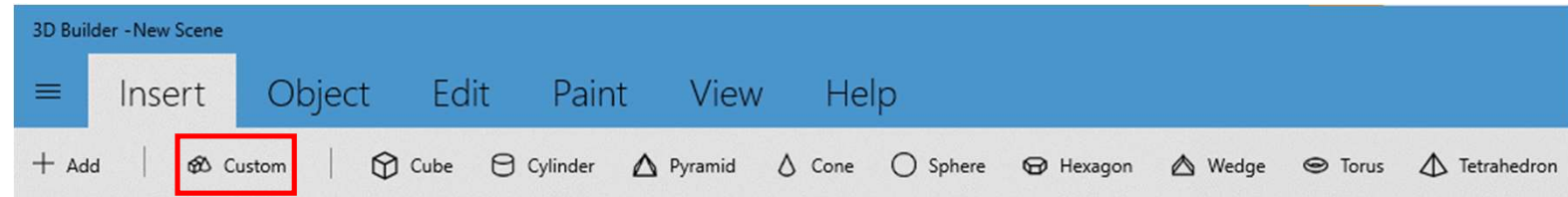



Microsoft 3D Builder

3D Builder Interface

Command Row SHAPE

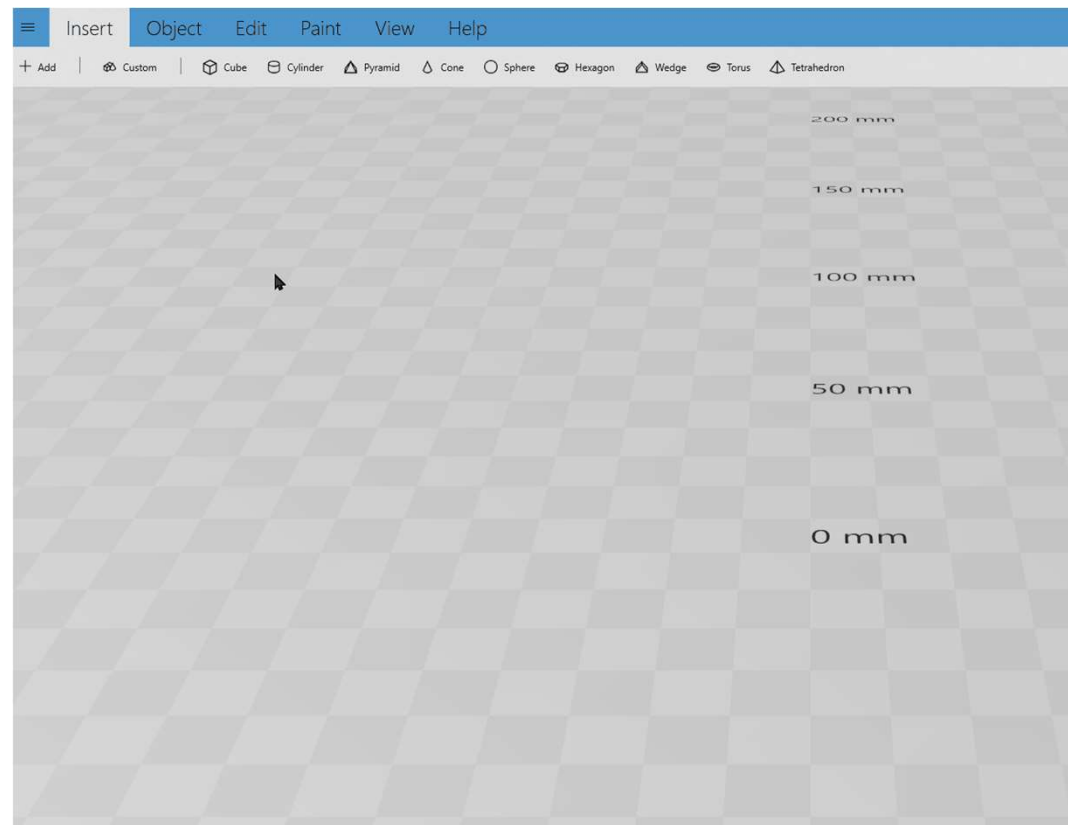
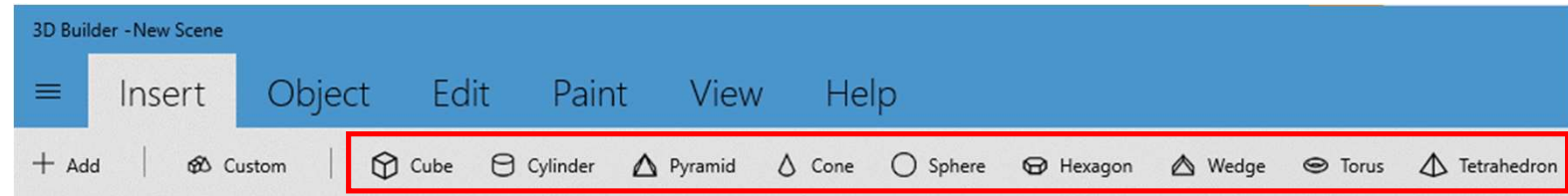



Microsoft 3D Builder

3D Builder Interface

Command Row
SHAPE -
ITEM COLUMN

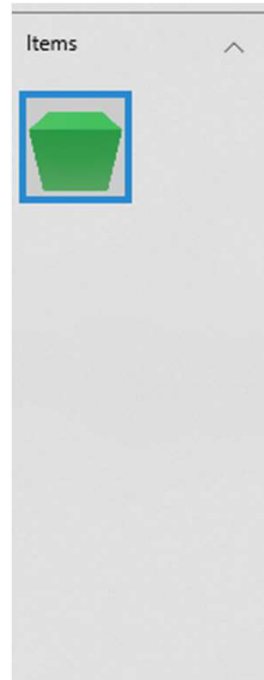
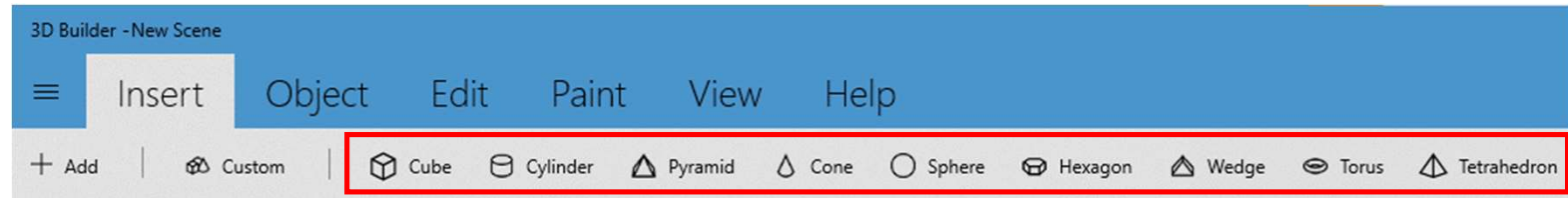



Microsoft 3D Builder

3D Builder Interface

Command Row
SHAPE -
ITEM COLUMN

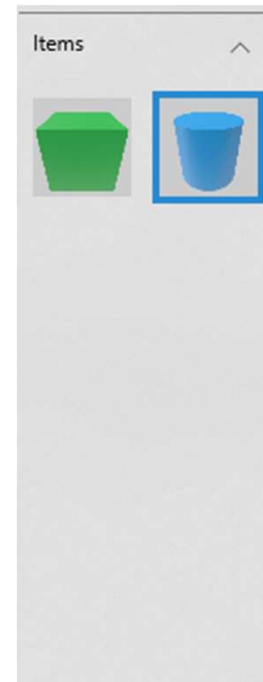
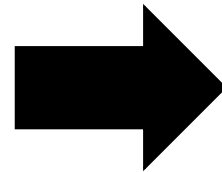
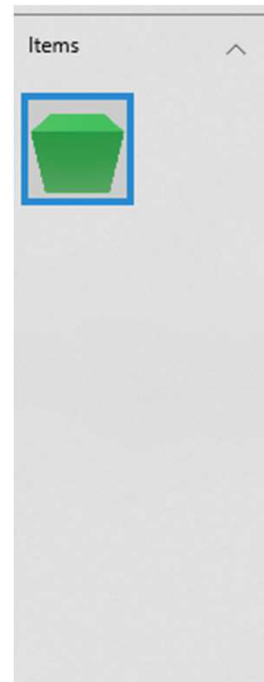
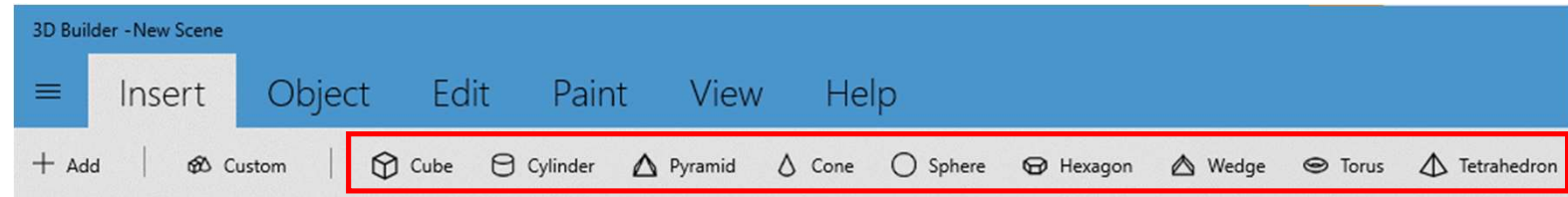



Microsoft 3D Builder

3D Builder Interface

Command Row
SHAPE -
ITEM COLUMN

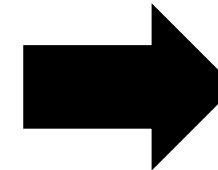
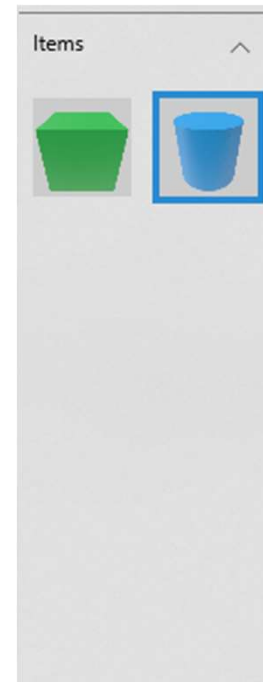
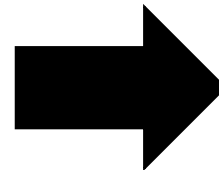
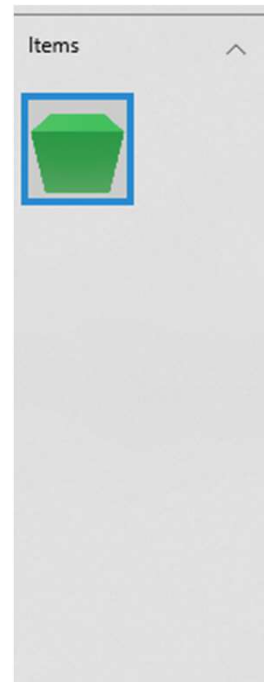
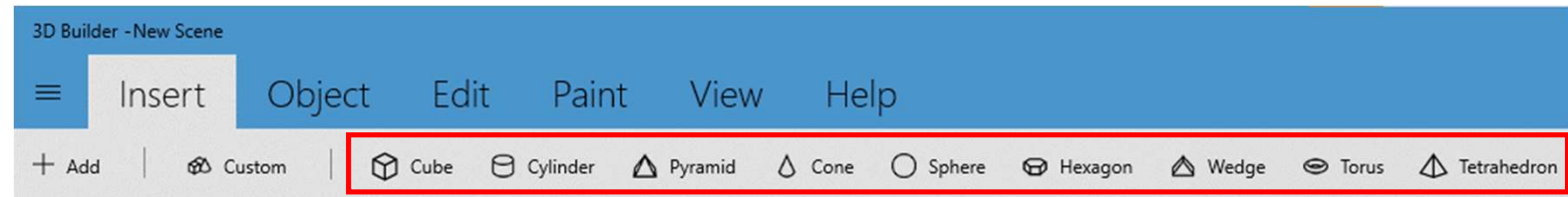



Microsoft 3D Builder

3D Builder Interface

Get around in the area:

- Zoom (Scroll)
- Rotate (Left click and hold on grid)
- Shift (Right click and hold on grid)

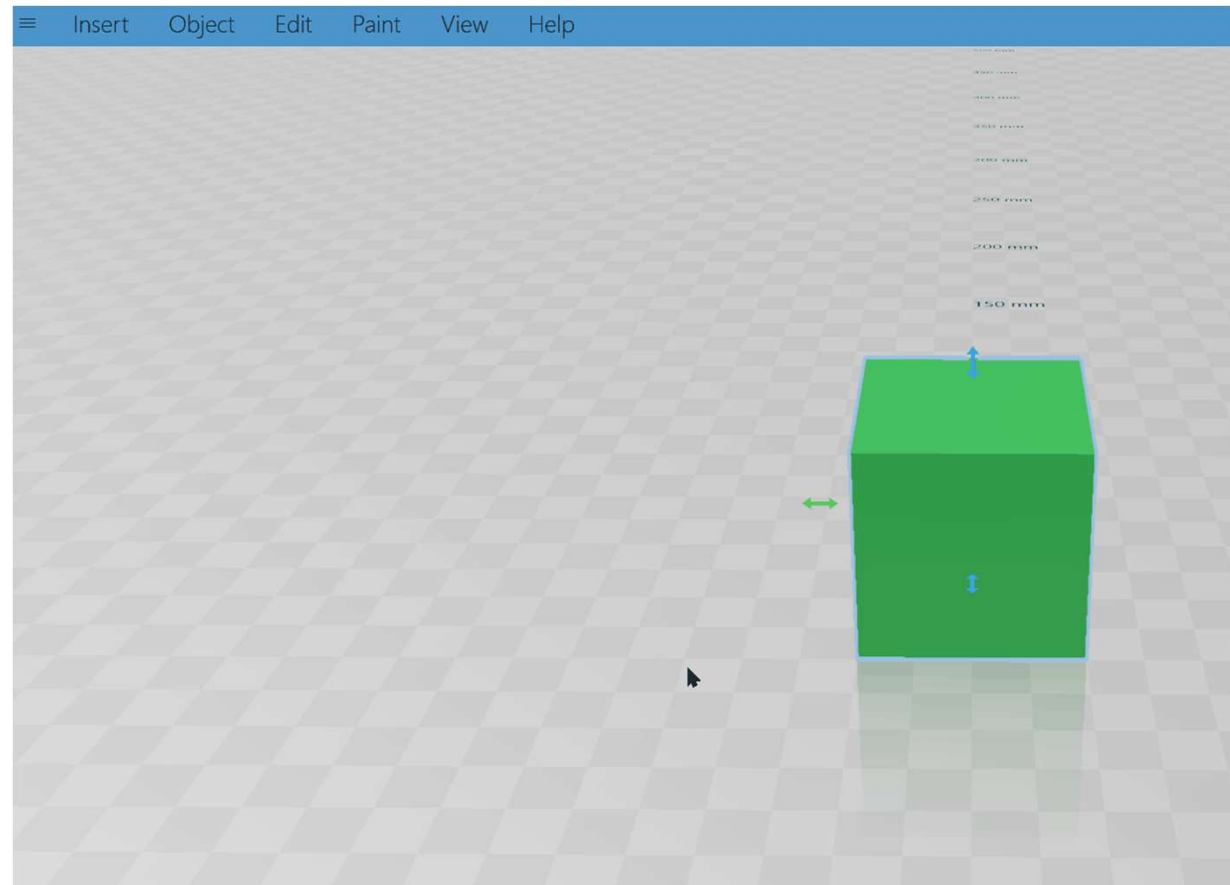



Microsoft 3D Builder

3D Builder Interface

Command Row

SHAPE -

MOVE, ROTATE, TRANSFORM

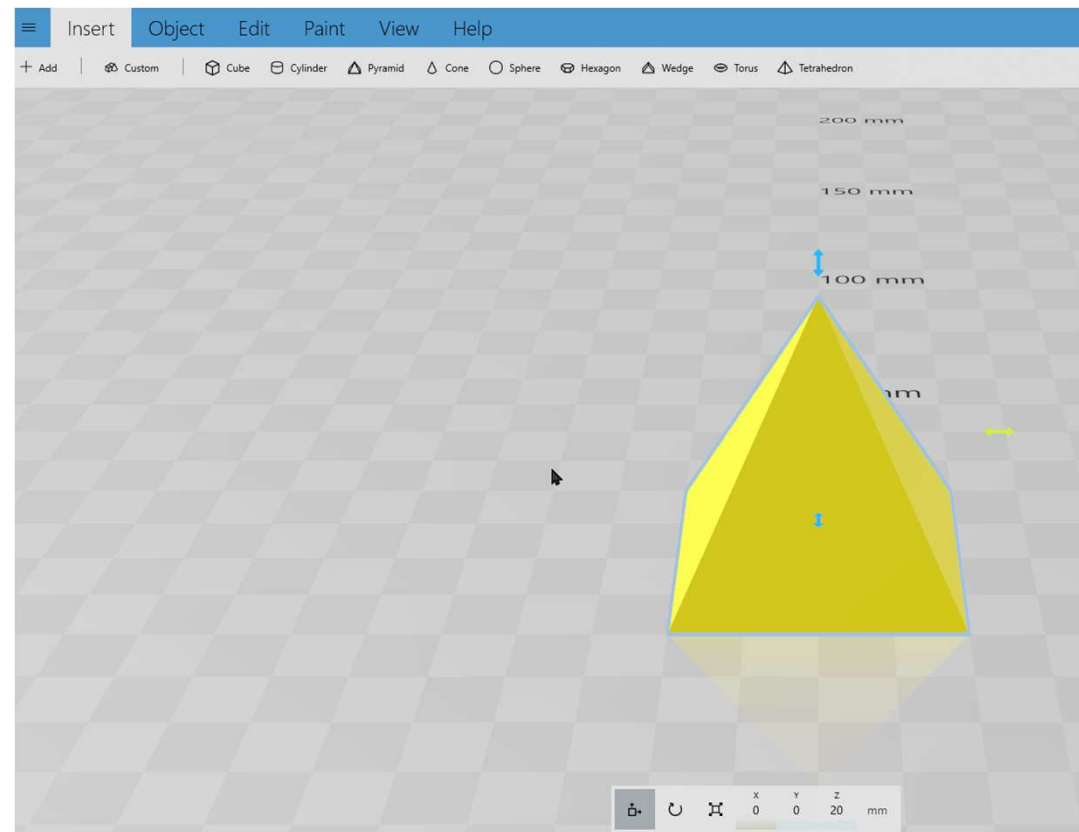
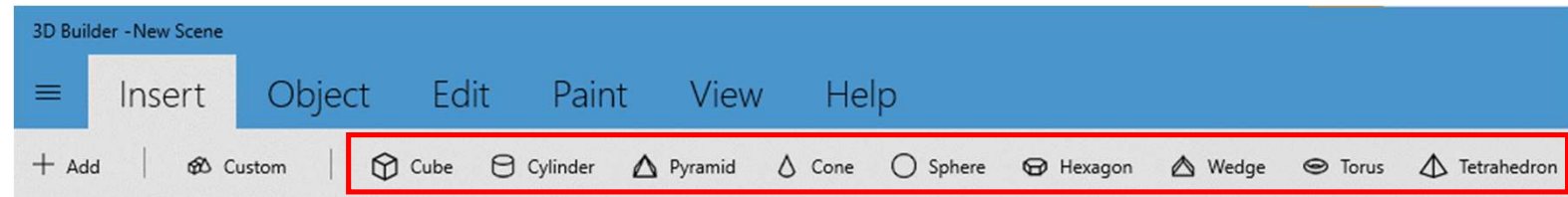



Microsoft 3D Builder

3D Builder Interface

Command Row

SHAPE -

MOVE, ROTATE, TRANSFORM

SET

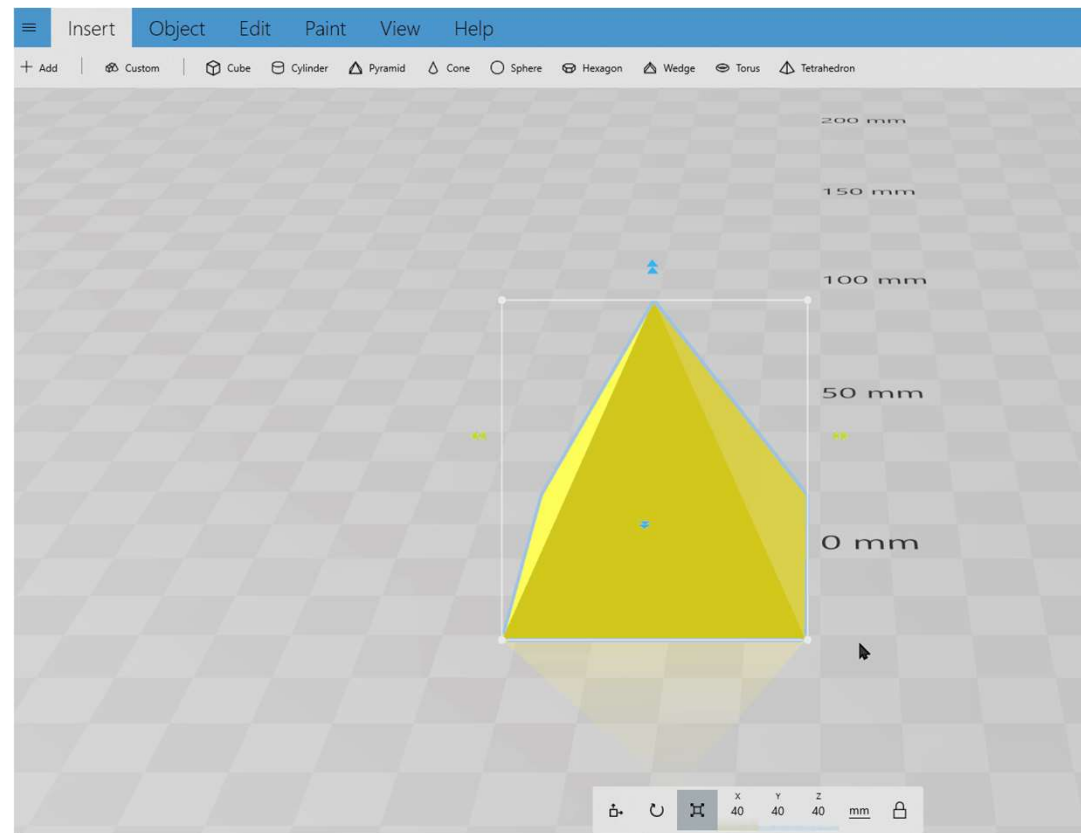
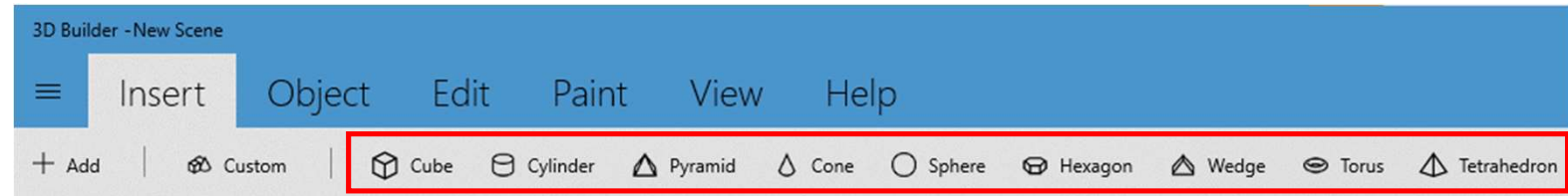

3D Drawing



Microsoft 3D Builder

3D Builder Interface

Command Row DUPLICATE

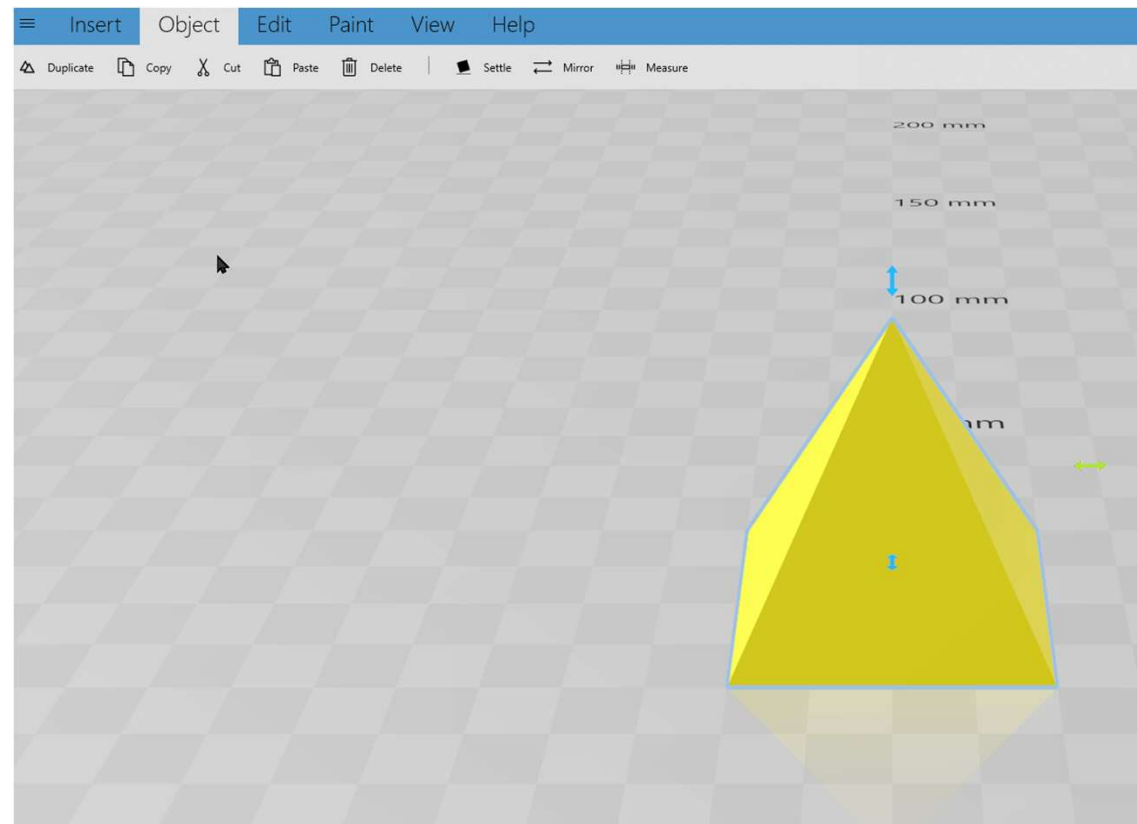
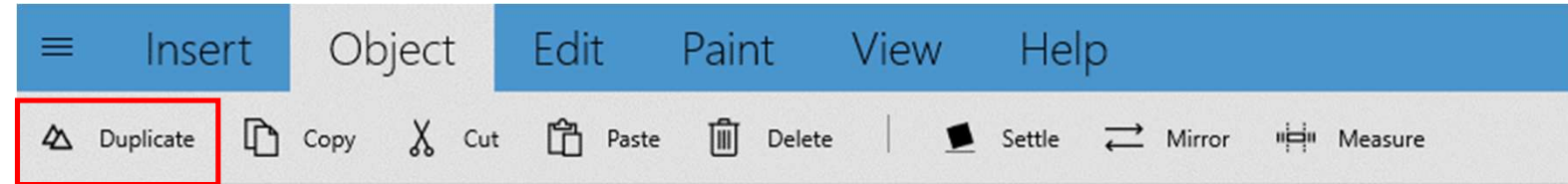



Microsoft 3D Builder

3D Builder Interface

Command Row

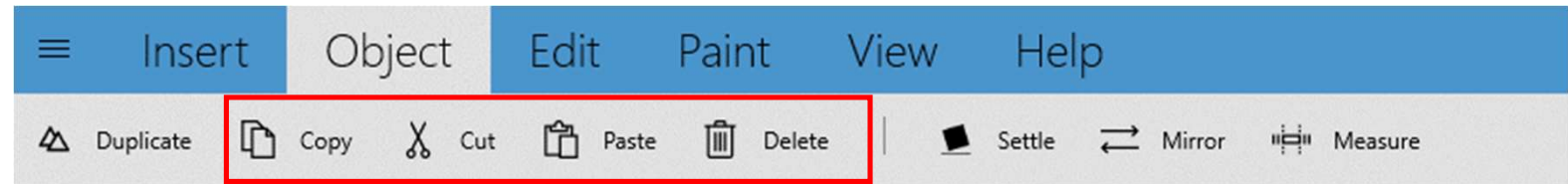

Copy, Cut, Paste, Delete



Microsoft 3D Builder

3D Builder Interface

Command Row SETTLE

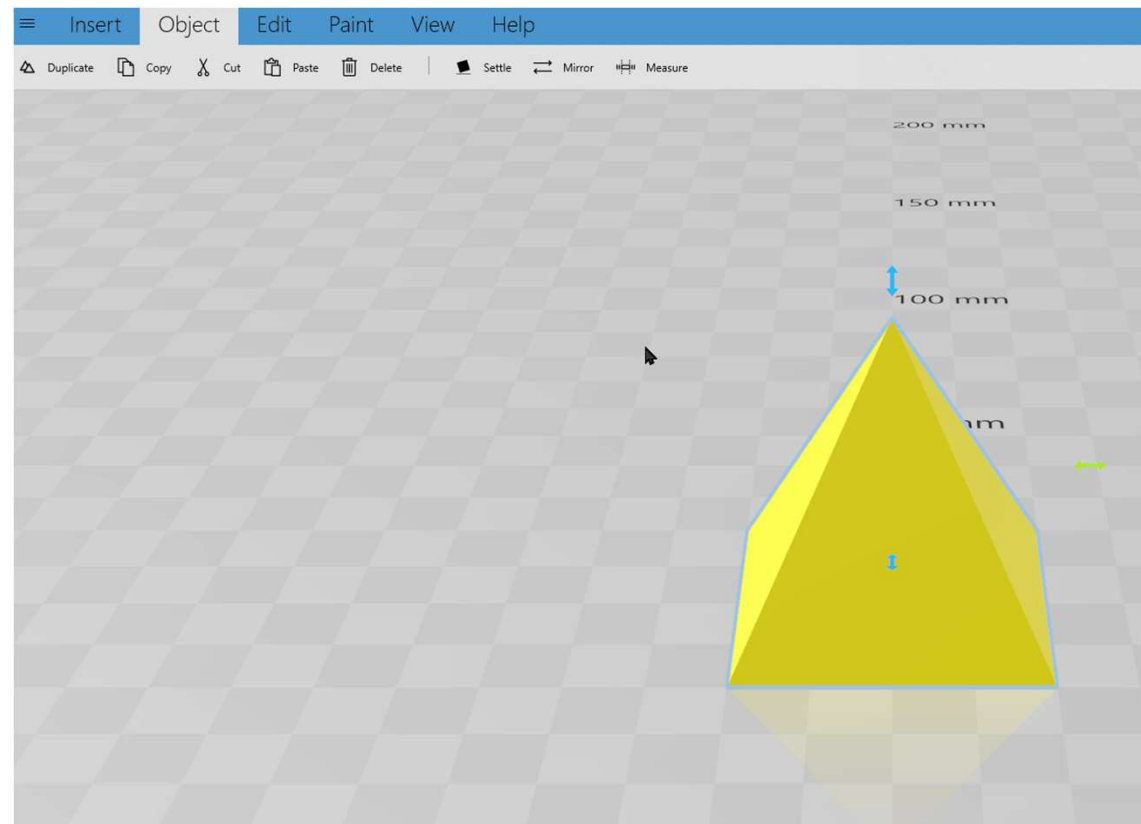
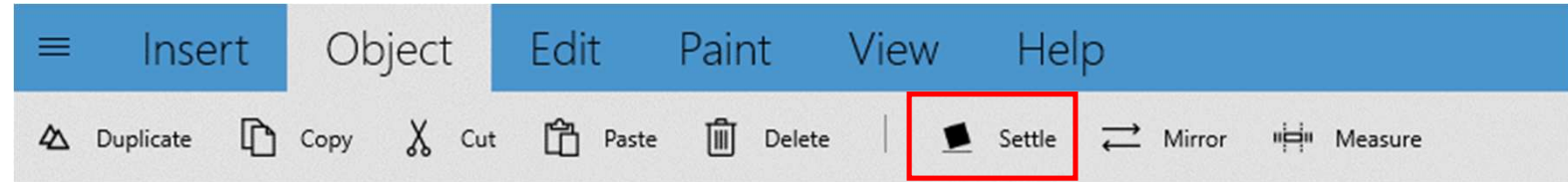

Microsoft 3D Builder

3D Builder Interface

Command Row

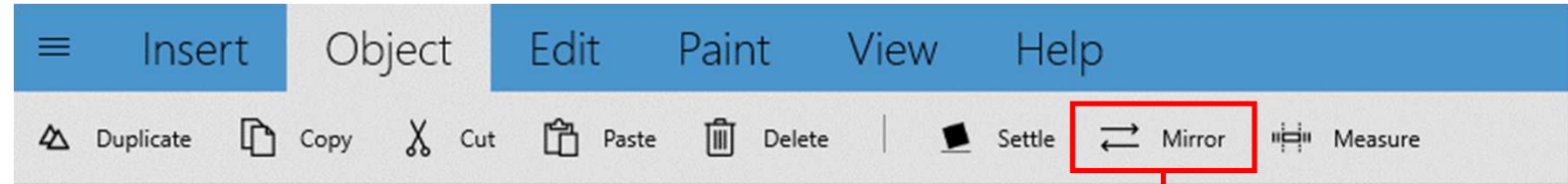

Mirror Horizontally

Microsoft 3D Builder

3D Builder Interface

Command Row MEASURE

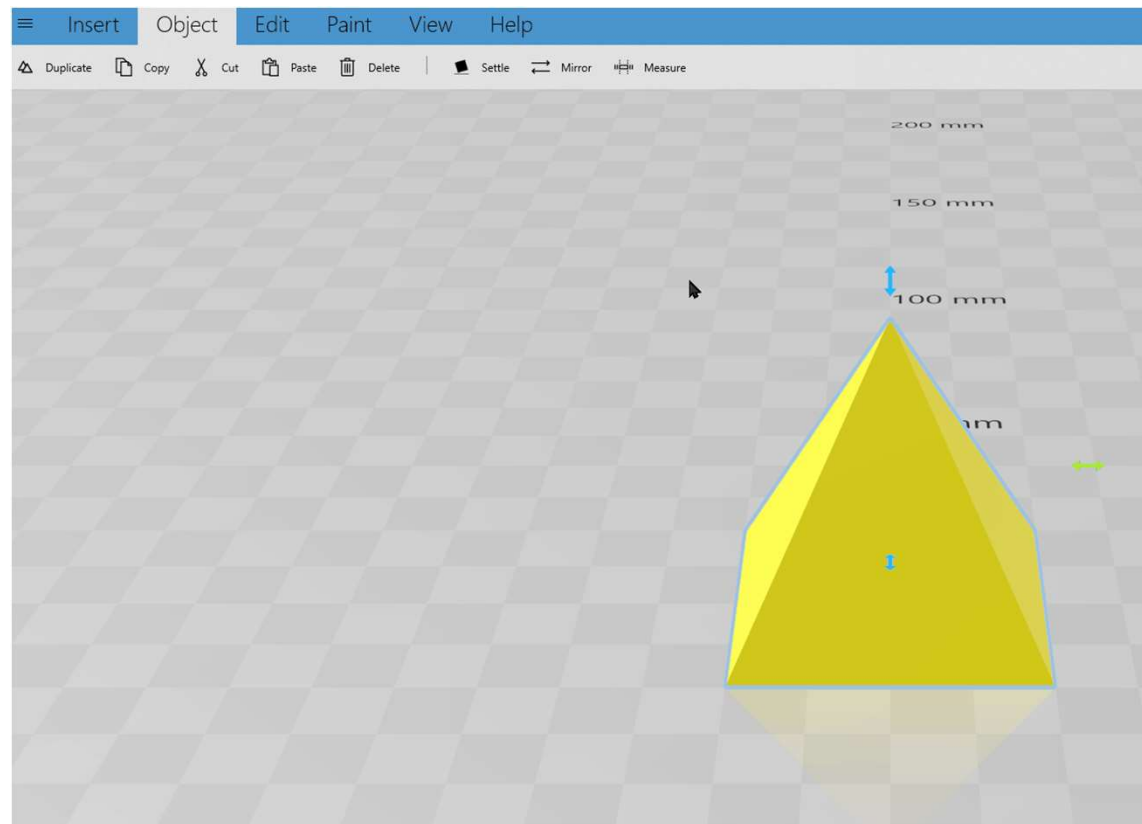
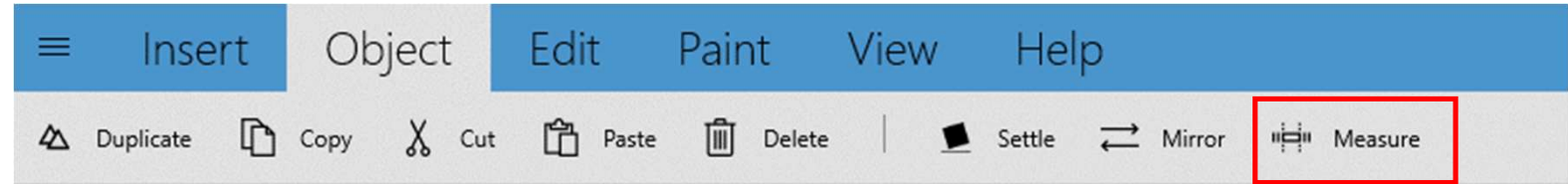



Microsoft 3D Builder

3D Builder Interface

Command Row



Simplify: Reduce details

Microsoft 3D Builder

3D Builder Interface

Command Row SPLIT

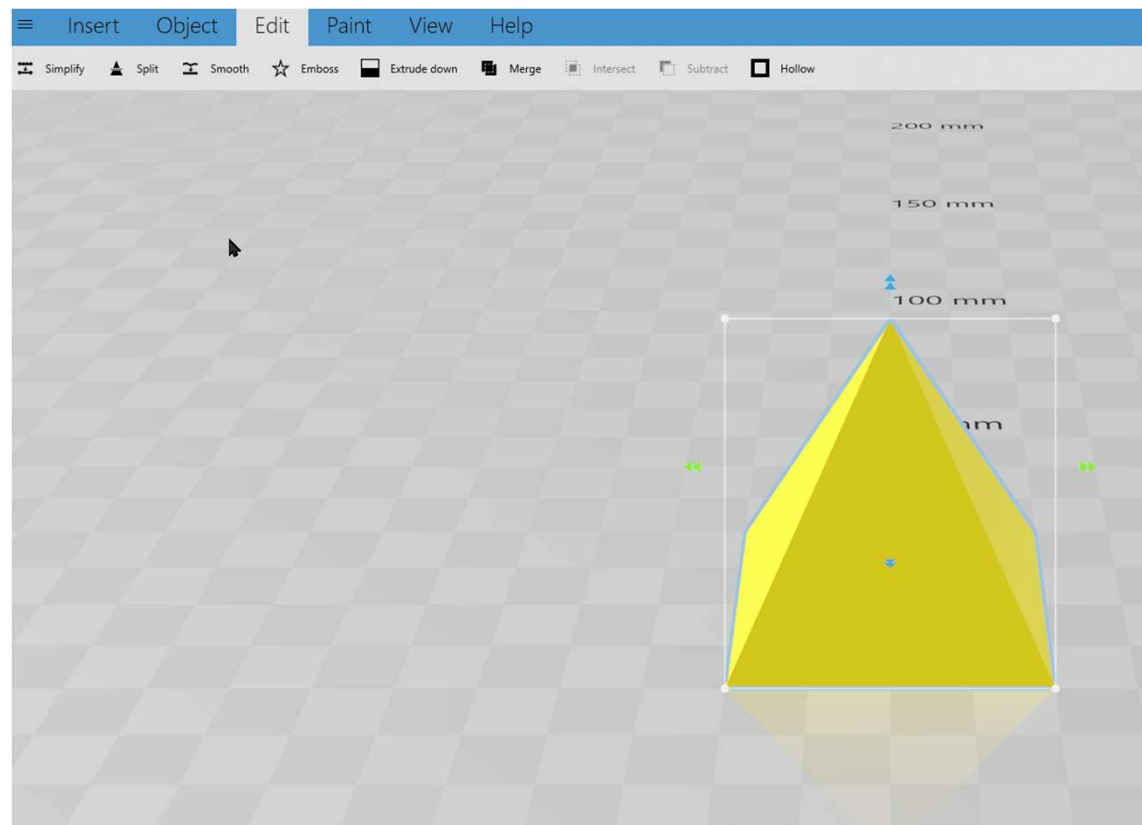
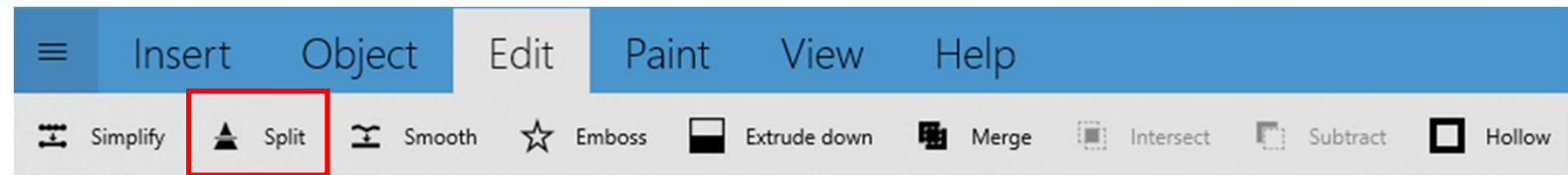

Microsoft 3D Builder

3D Builder Interface

Command Row SMOOTH

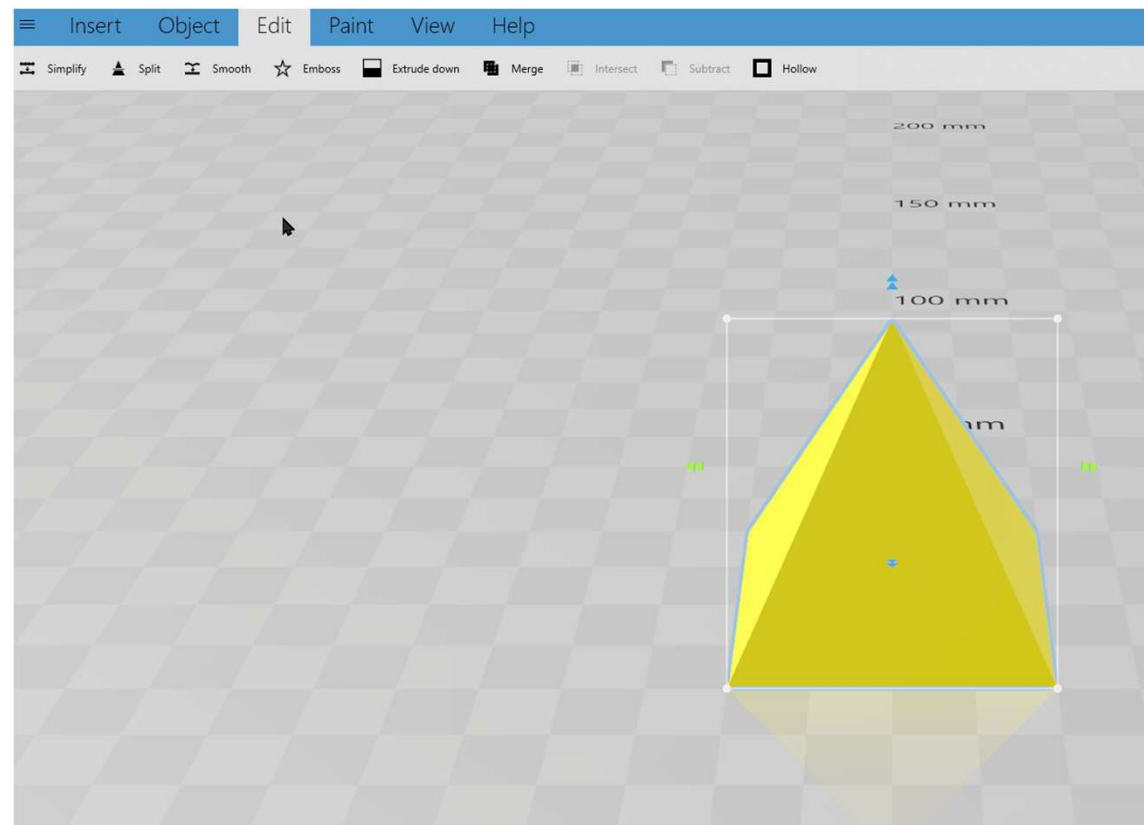
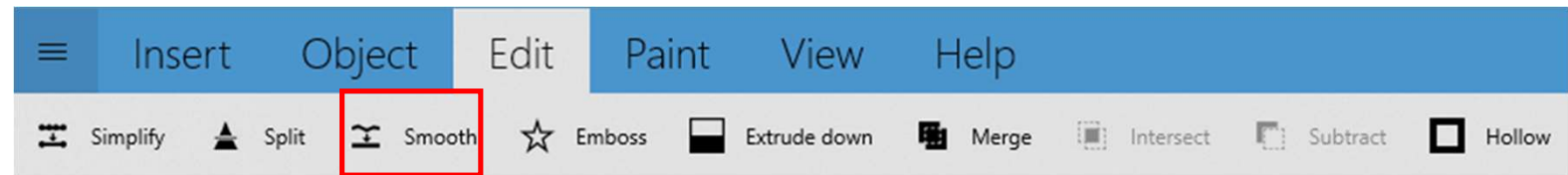

Microsoft 3D Builder

3D Builder Interface

Command Row EMBOSS

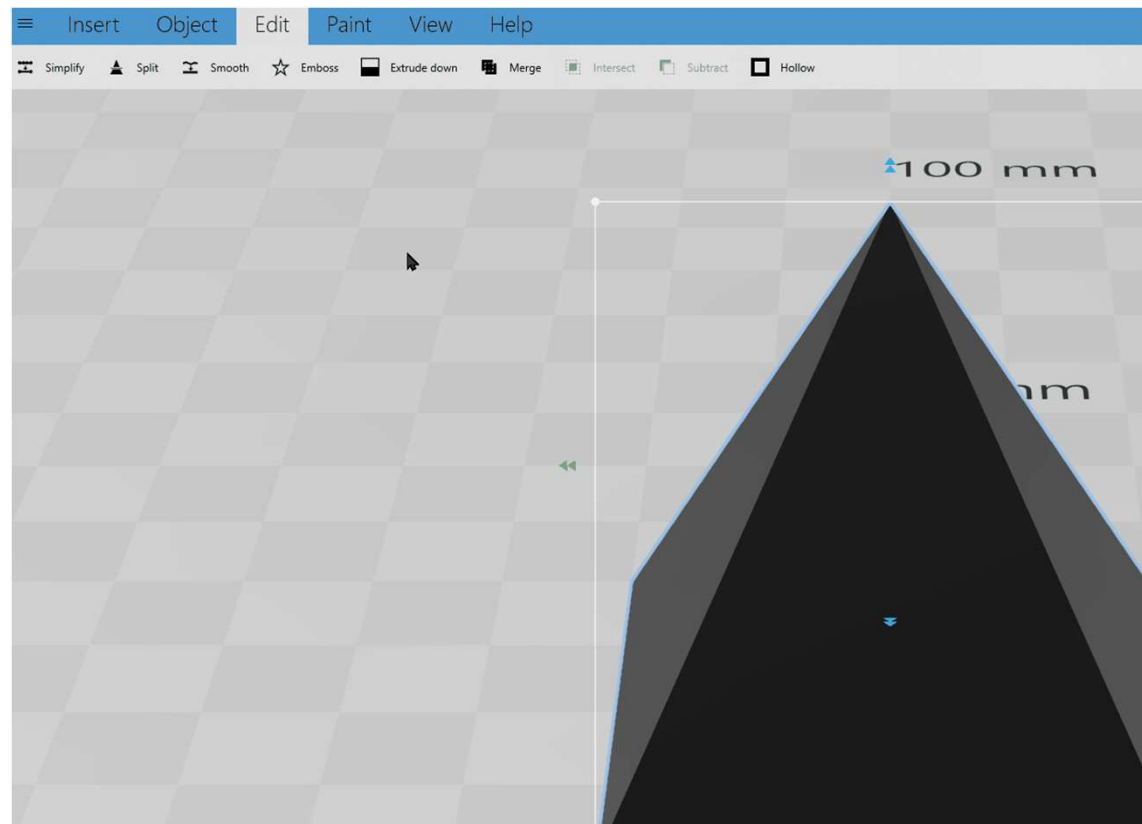
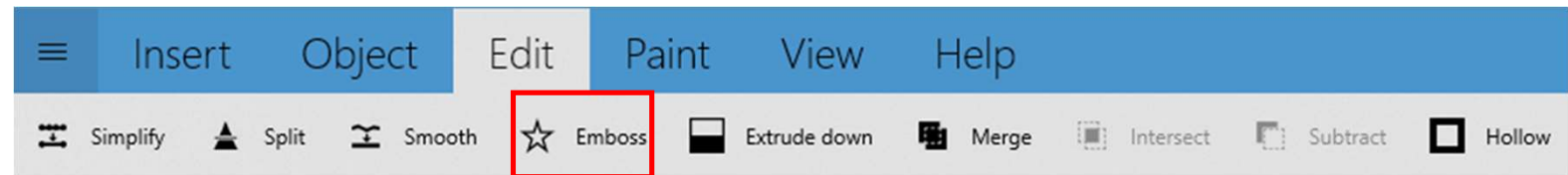

Microsoft 3D Builder

3D Builder Interface

Command Row MERGE

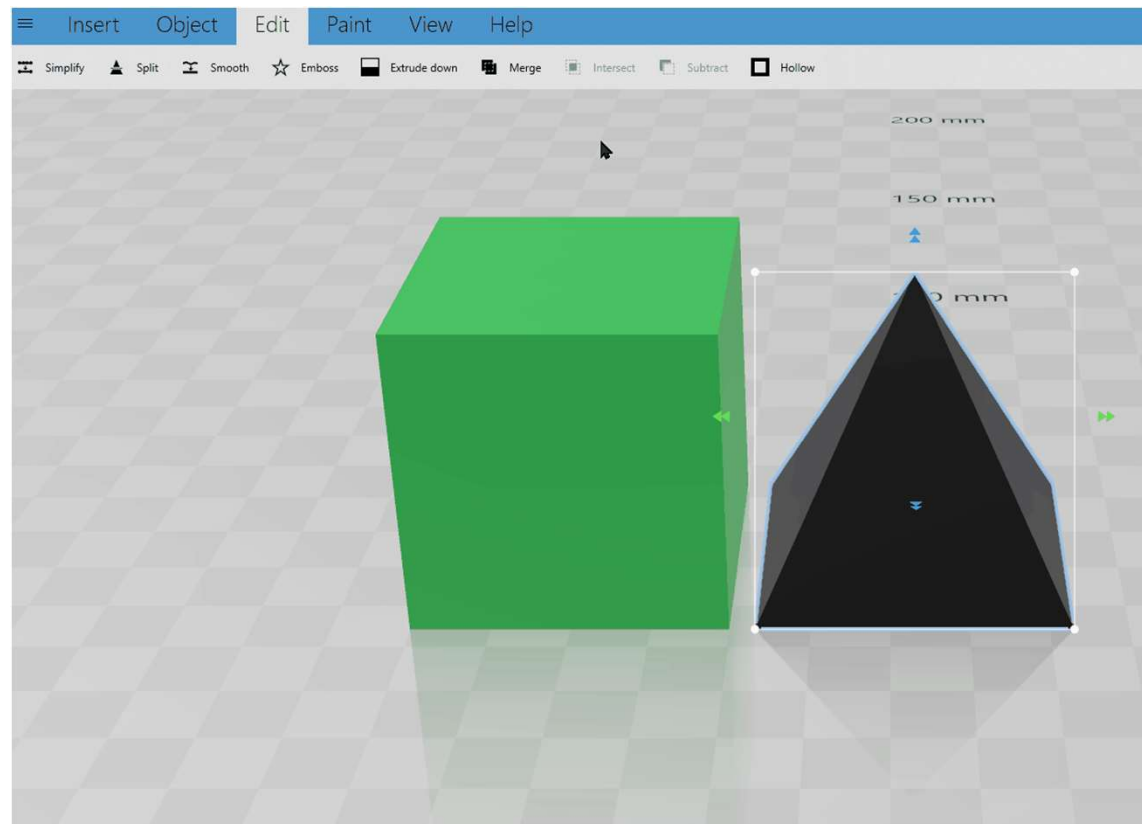
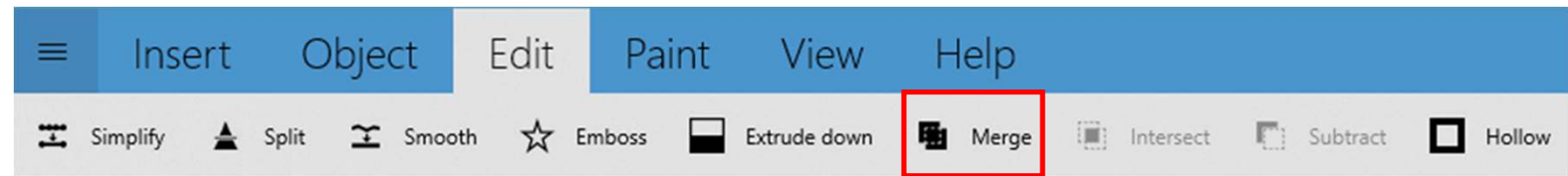

3D Drawing

Microsoft 3D Builder

3D Builder Interface

Command Row INTERSECT

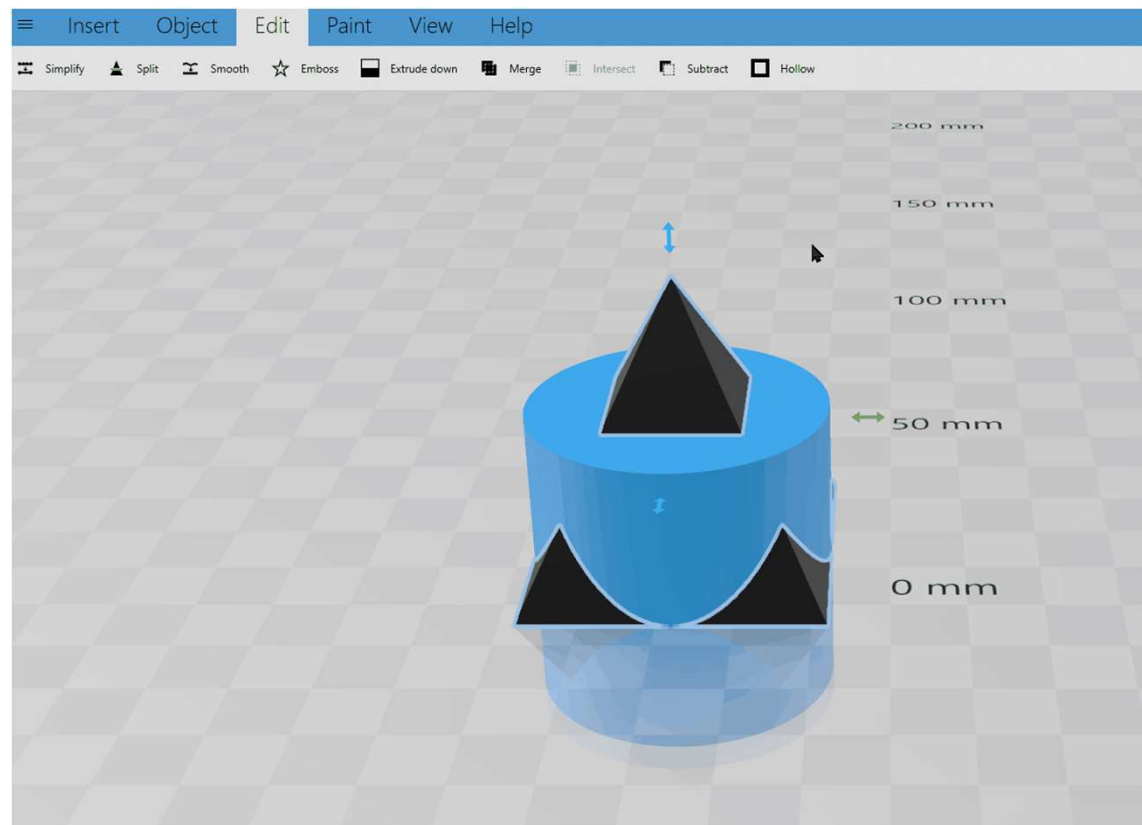
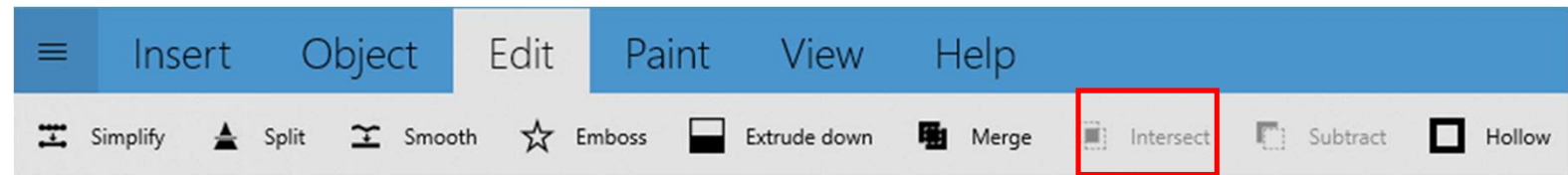

Microsoft 3D Builder

3D Builder Interface

Command Row
SUBTRACT
(opposite Intersect)

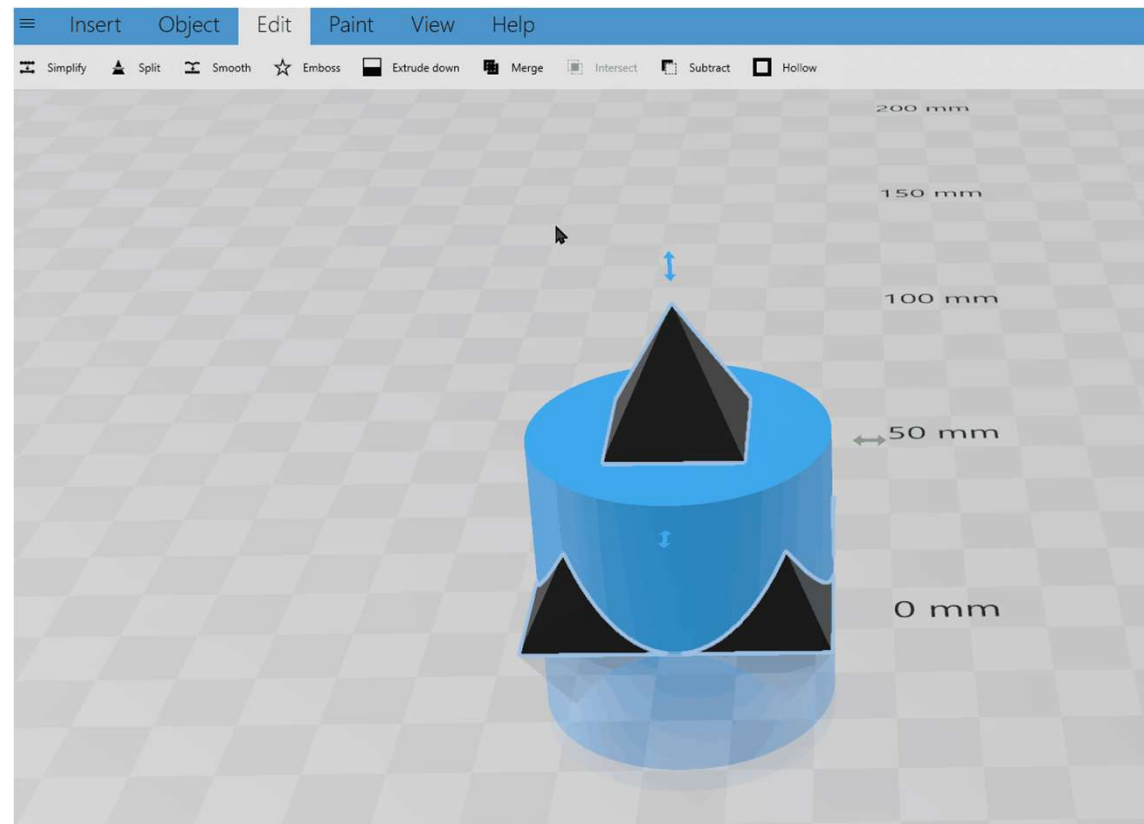
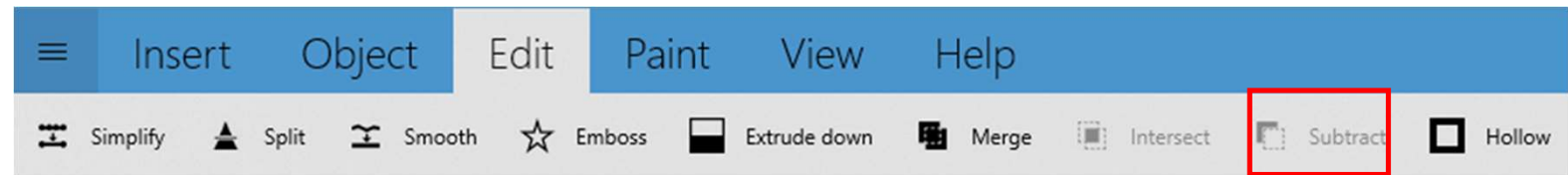

Microsoft 3D Builder

3D Builder Interface

Command Row
HOLLOW

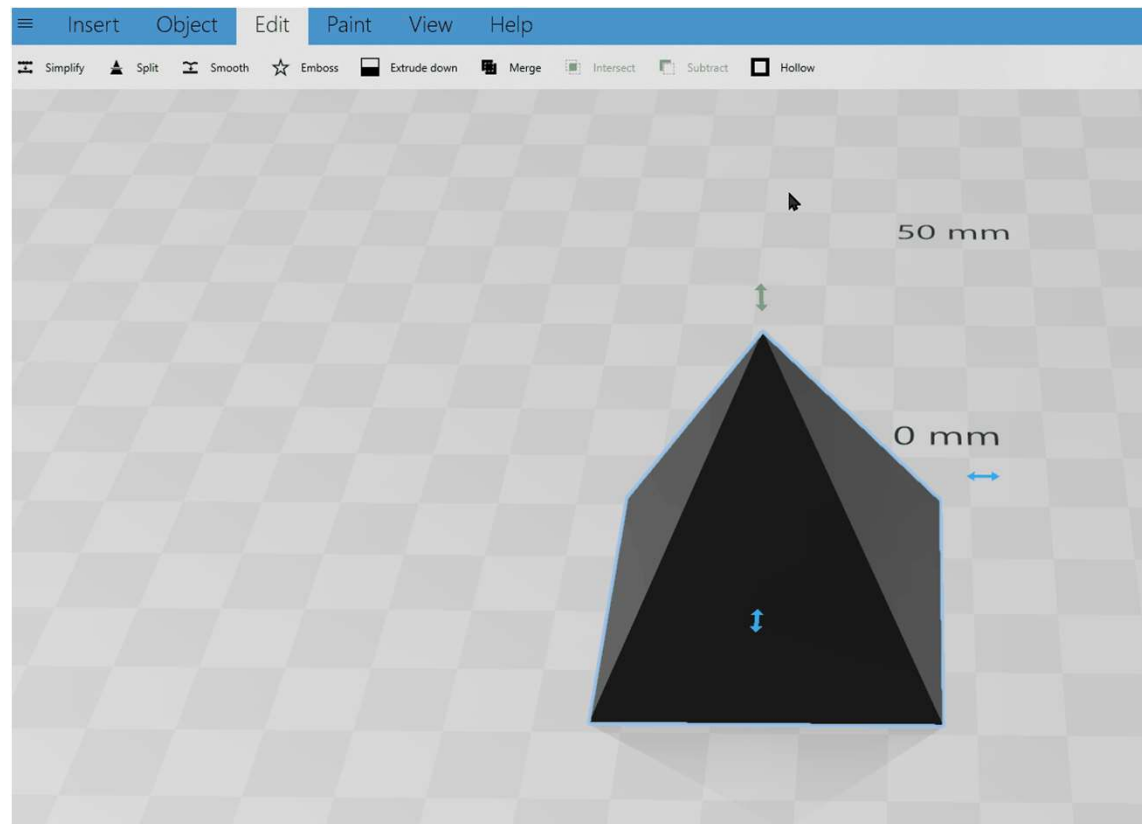
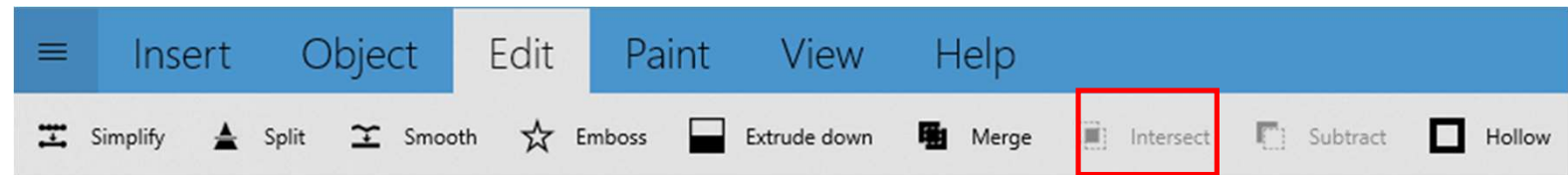



Microsoft 3D Builder

3D Builder Interface

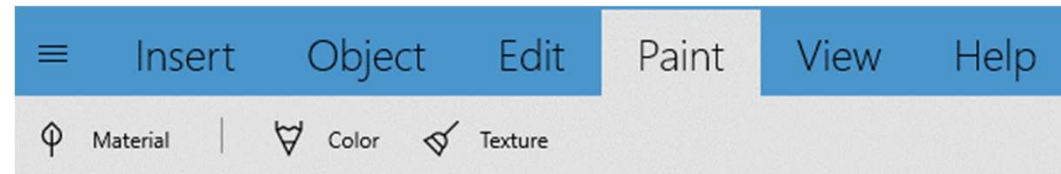

Command Row PAINT





Microsoft 3D Builder

3D Builder Interface

Command Row PAINT

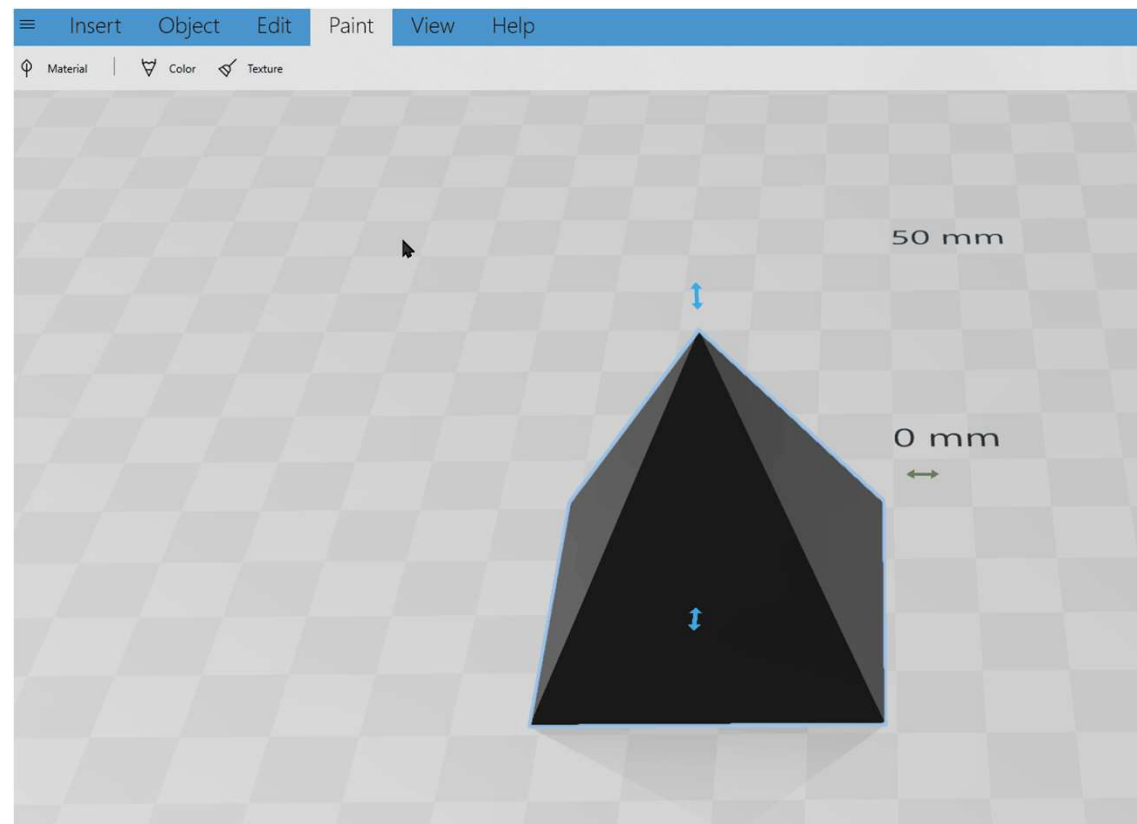
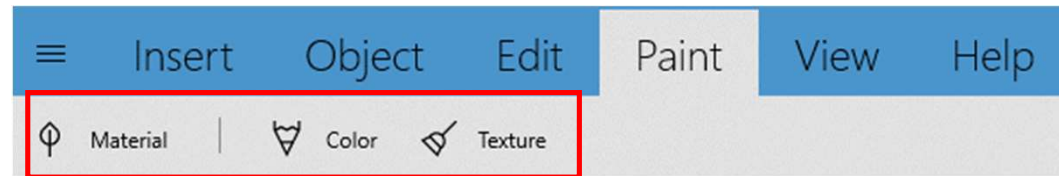



Microsoft 3D Builder

3D Builder Interface

Command Row VIEW

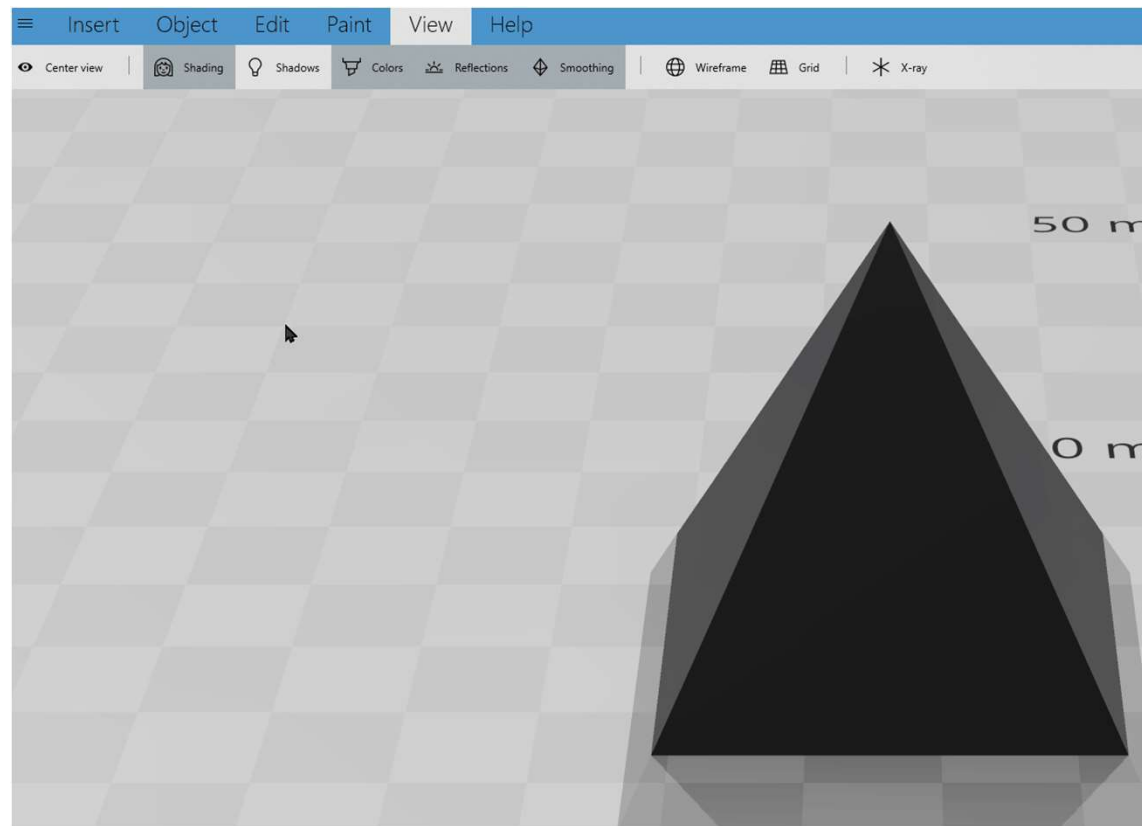
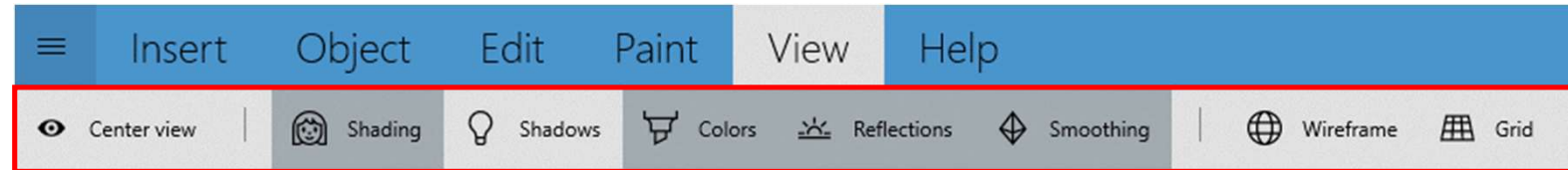



Microsoft 3D Builder

3D Builder Interface

Command Row

3D Print
Local or Online
Service

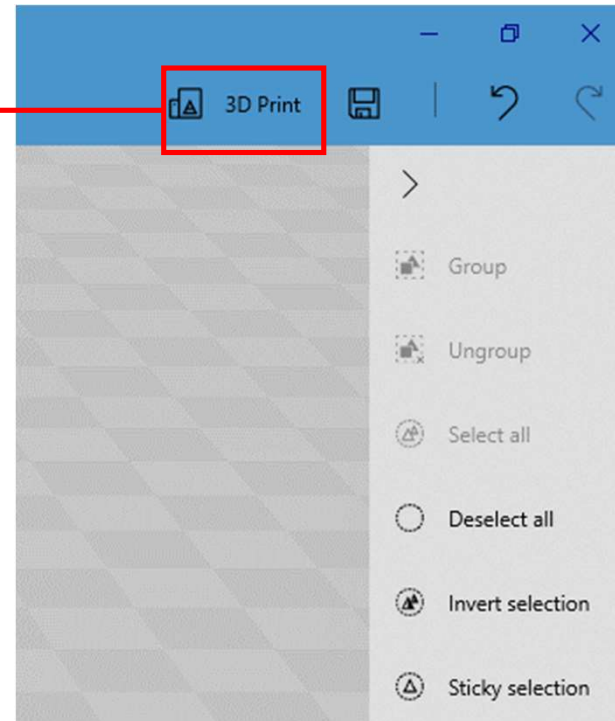



Microsoft 3D Builder

3D Builder Interface

Command Row

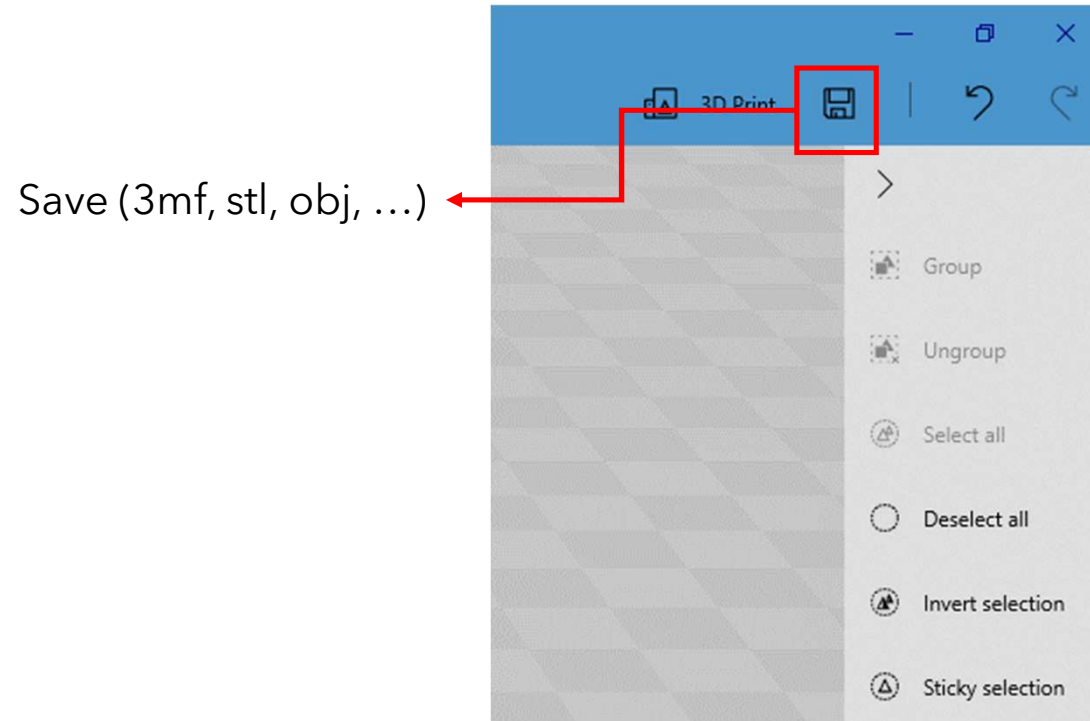



Microsoft 3D Builder

3D Builder Interface

Command Row

Group (as Merge)
/Ungroup

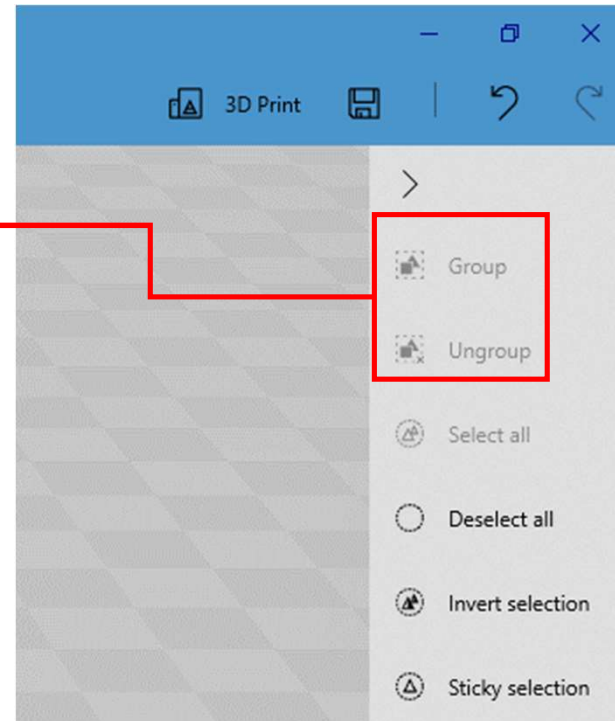



Microsoft 3D Builder

3D Builder Interface

Command Row

Select All/
Deselect All/ Invert
selection

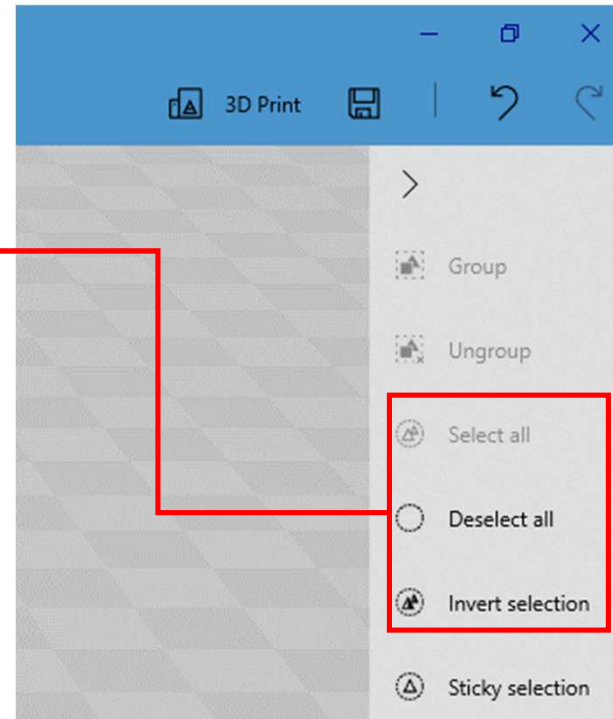



Microsoft 3D Builder

3D Builder Interface

Command Row

Sticky Extension

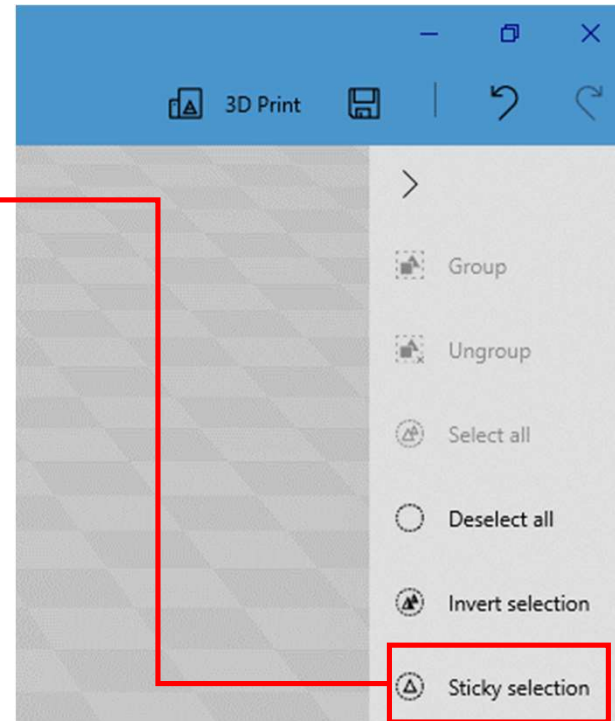



Autodesk
TinkerCad
(tinkercad.com)



Lyo

Search designs...

3D Designs

Circuits

Codeblocks

NEW

Lessons

Your Classes

Collections

Pixy

ARCA

JoyStick Case

My recent designs

Create new design

Select

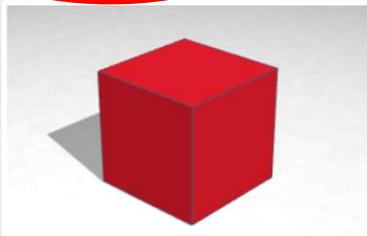

ABeyGa
4 giorni fa
Private



Grifone
5 giorni fa
Private

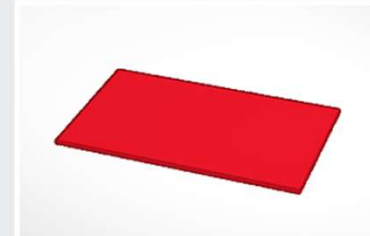

scudo DiegoI
18 giorni fa
Private

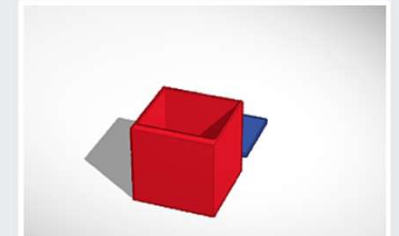

iCube Box
2 mesi fa
Private

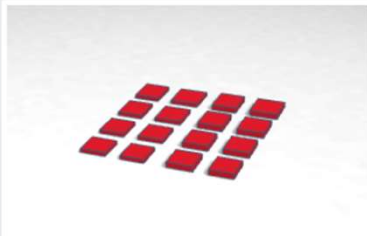

Blocchetti Sodalizio

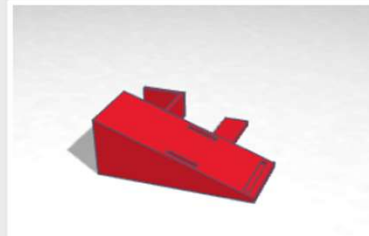

Cuneo Fibaro PIR

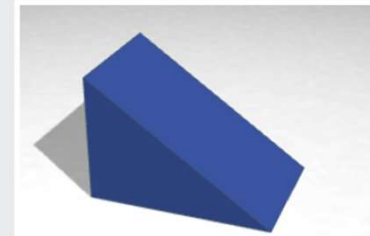

Cuneo MailaB

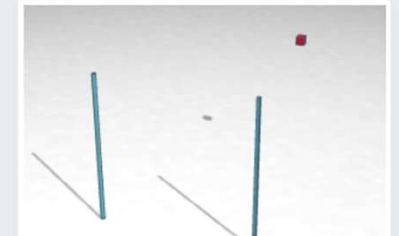

Incavo cubo



Autodesk TinkerCad

TinkerCad interface

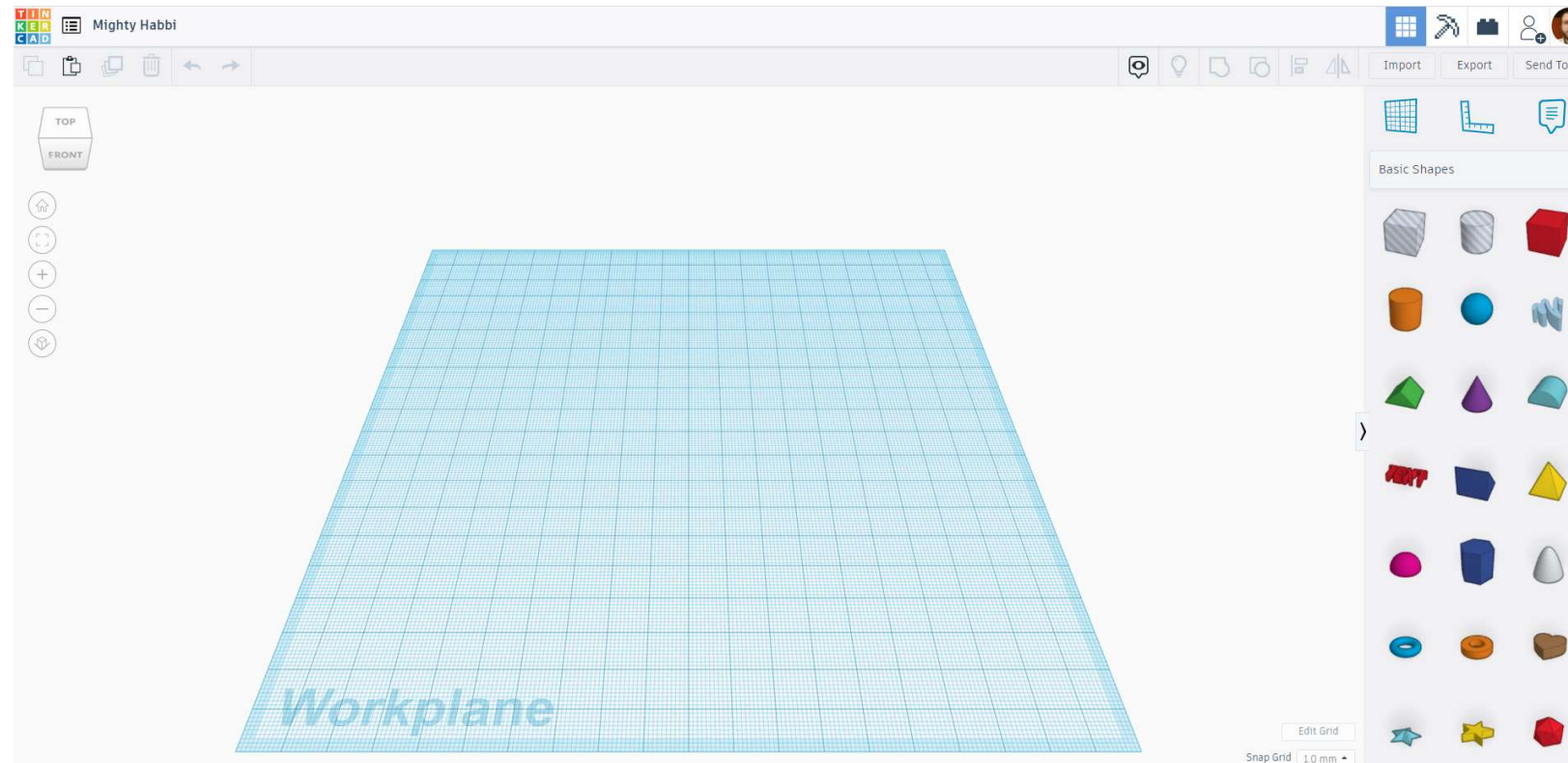



Autodesk TinkerCad

TinkerCad interface

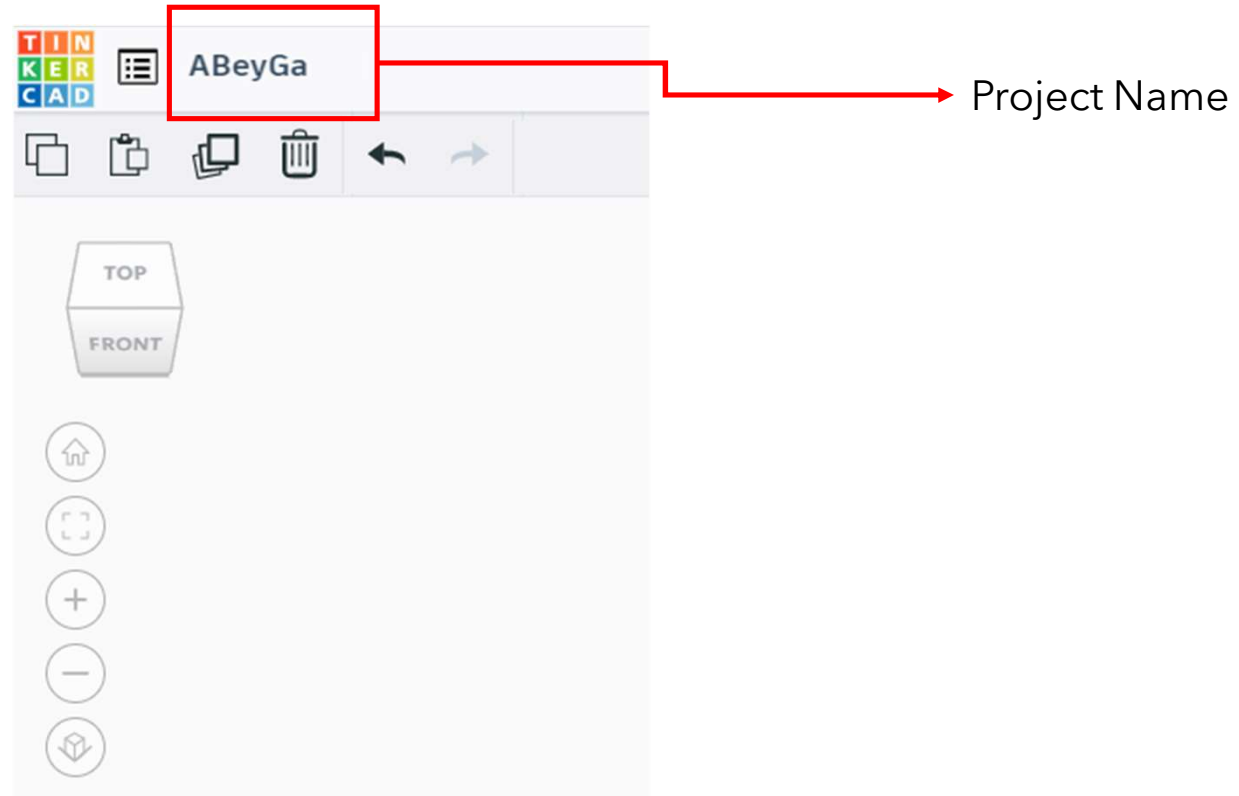



Autodesk TinkerCad

TinkerCad interface

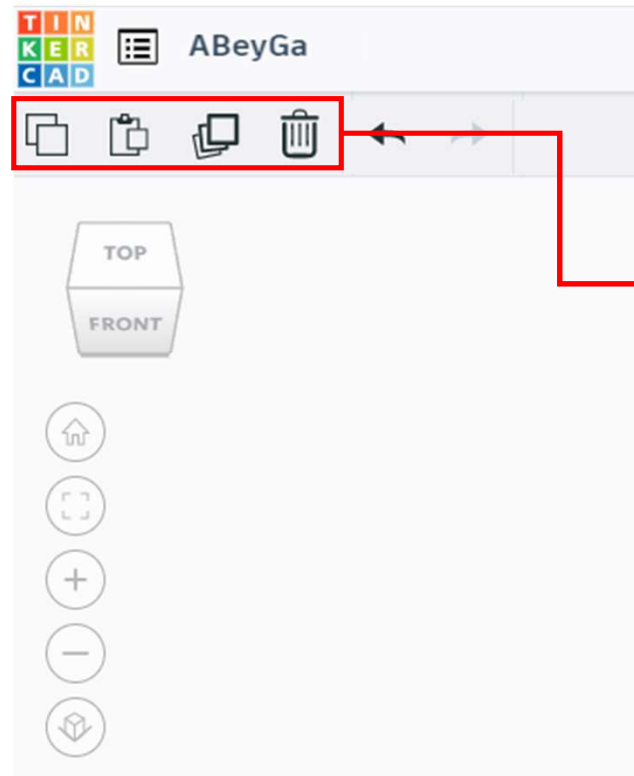

- Copy
- Paste
- Duplicate & Repeat
- Delete



Autodesk TinkerCad

TinkerCad interface

Duplicate & Repeat
Or
Copy & Paste?

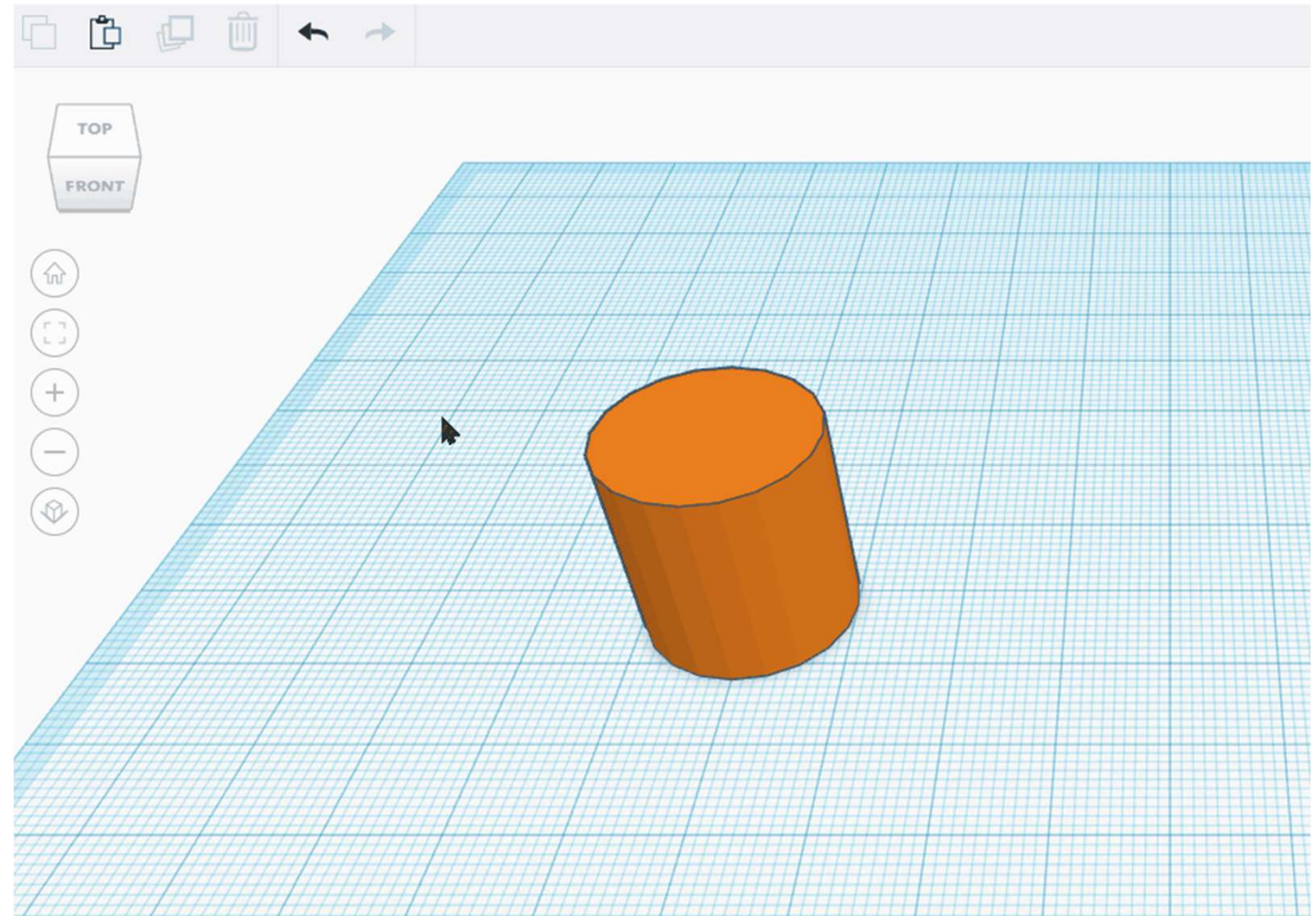



Autodesk TinkerCad

TinkerCad interface

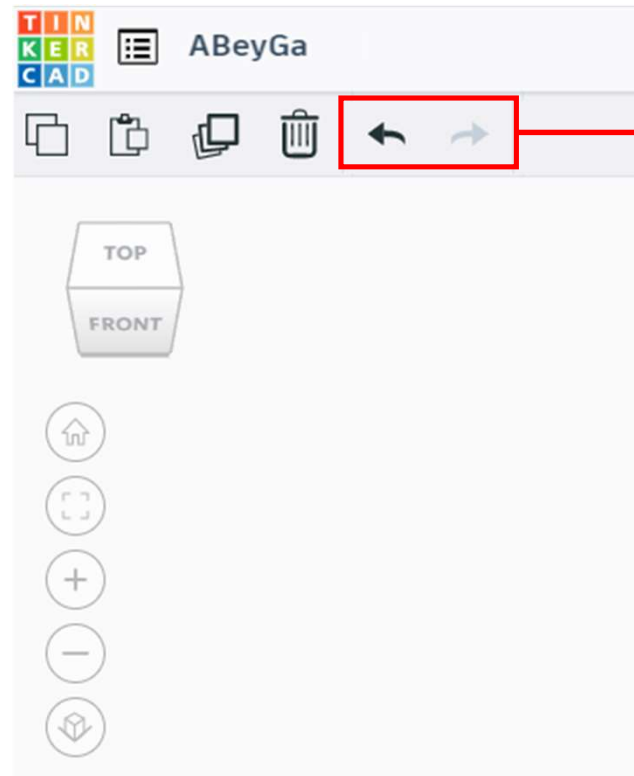

- Undo
- Redo



Autodesk TinkerCad

TinkerCad interface

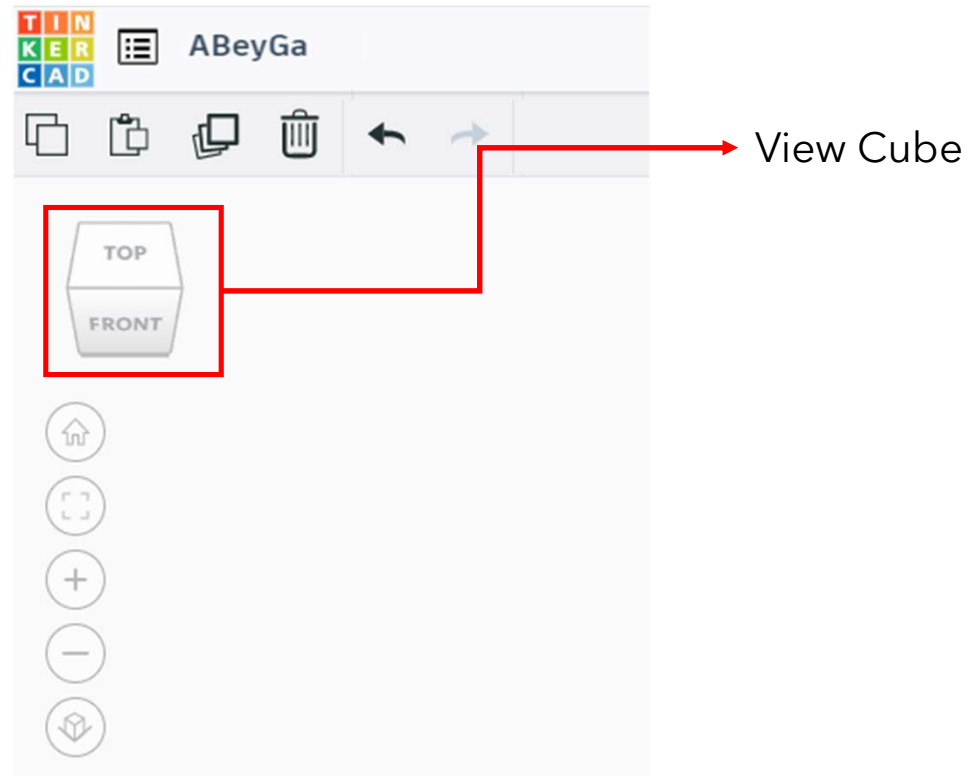

View Cube





Autodesk TinkerCad

TinkerCad interface

View Cube Click

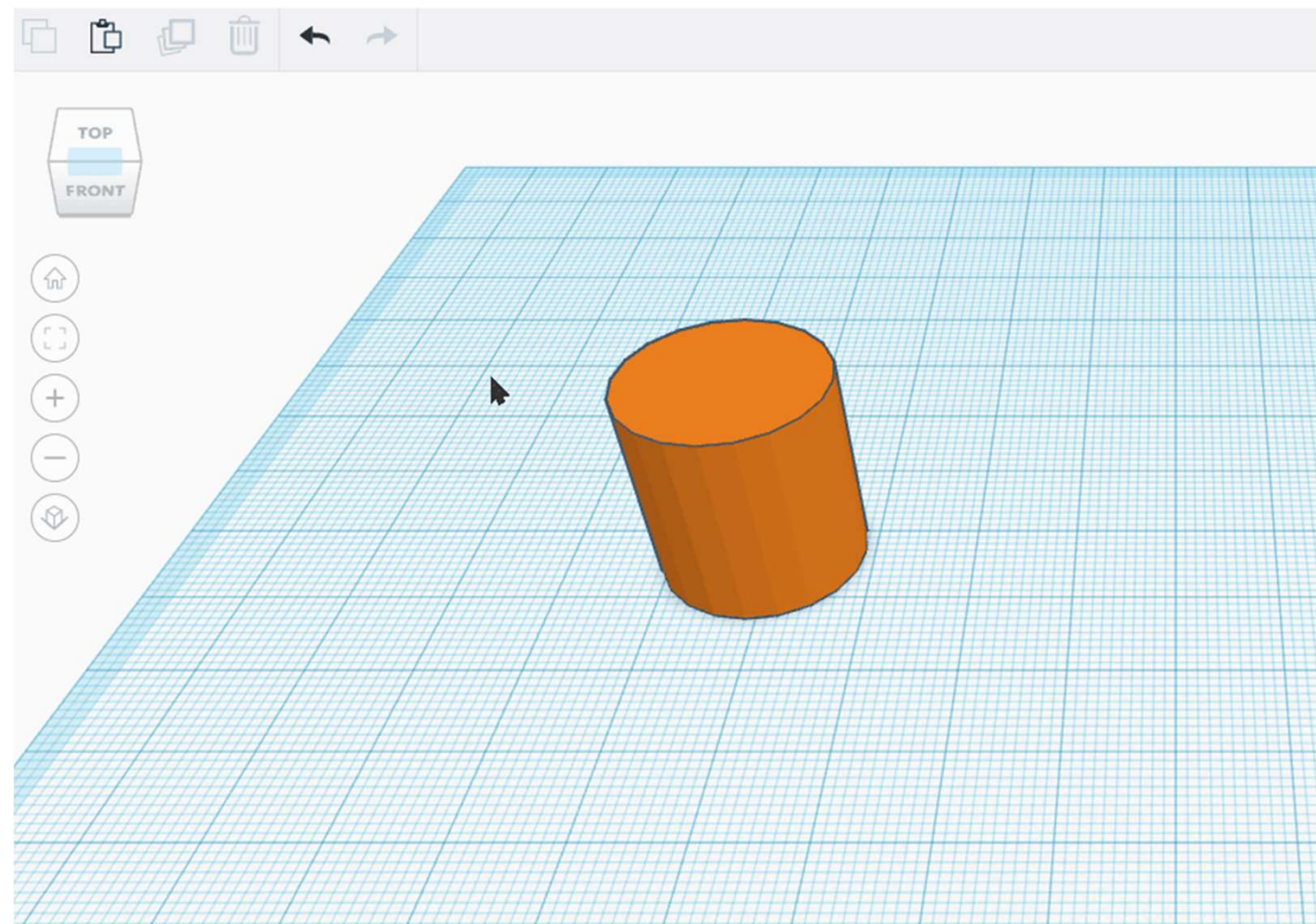



Autodesk TinkerCad

TinkerCad interface

View Cube Mouse

- Rotate (Right Click and hold)
- Pan (Center Click and hold)

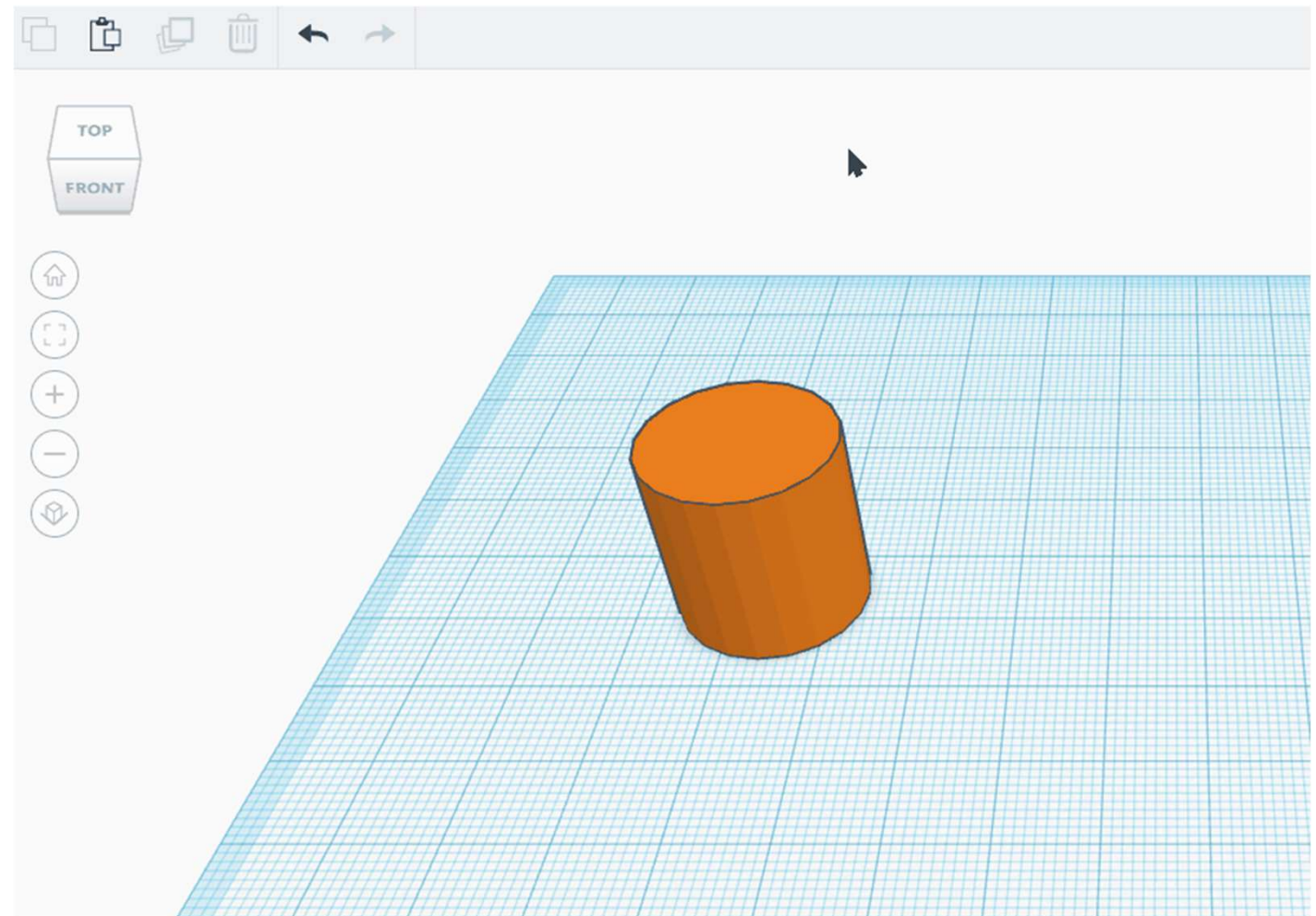



Autodesk TinkerCad

TinkerCad interface

Home view

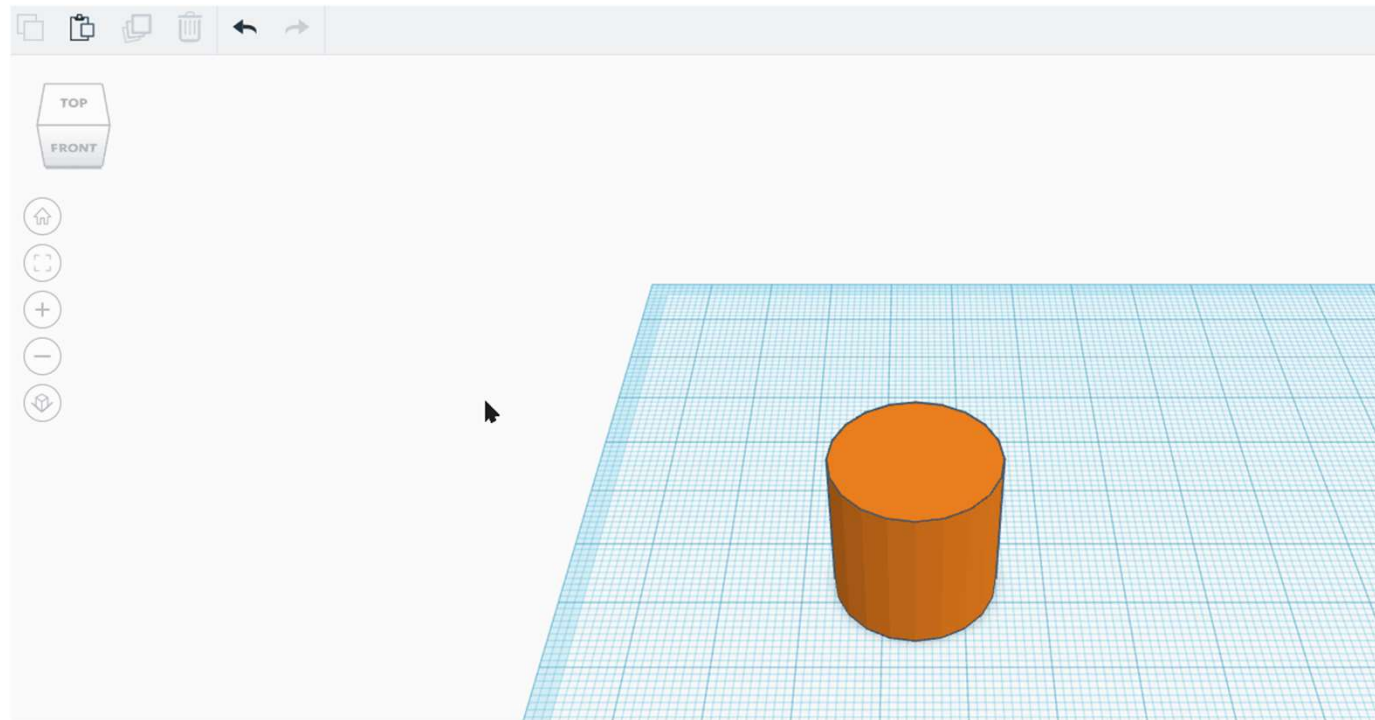



Autodesk TinkerCad

TinkerCad interface

Fit all in view

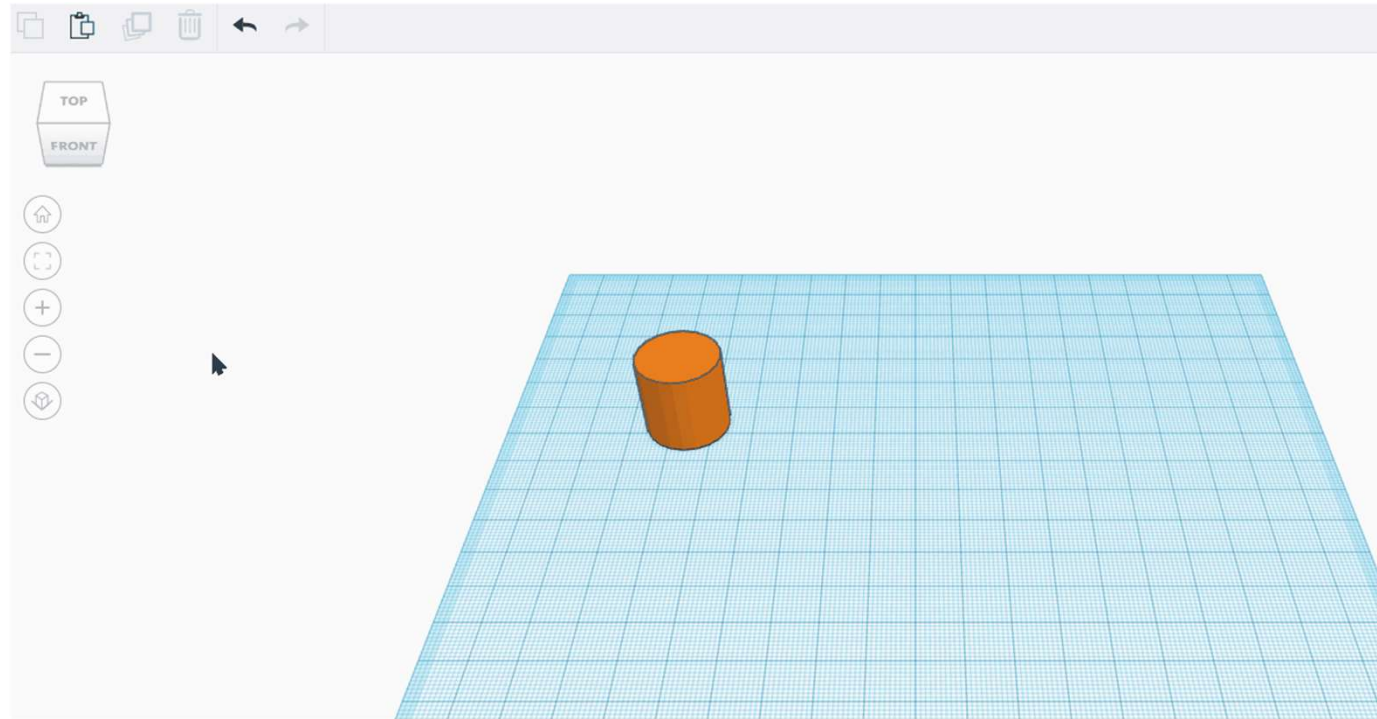
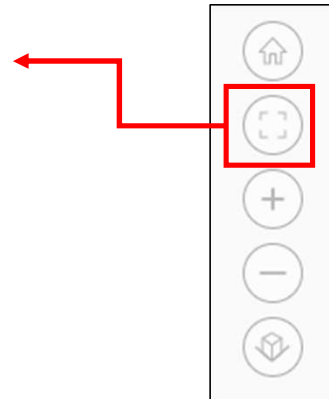



Autodesk TinkerCad

TinkerCad interface

Zoom in & out
(buttons and
scroll)

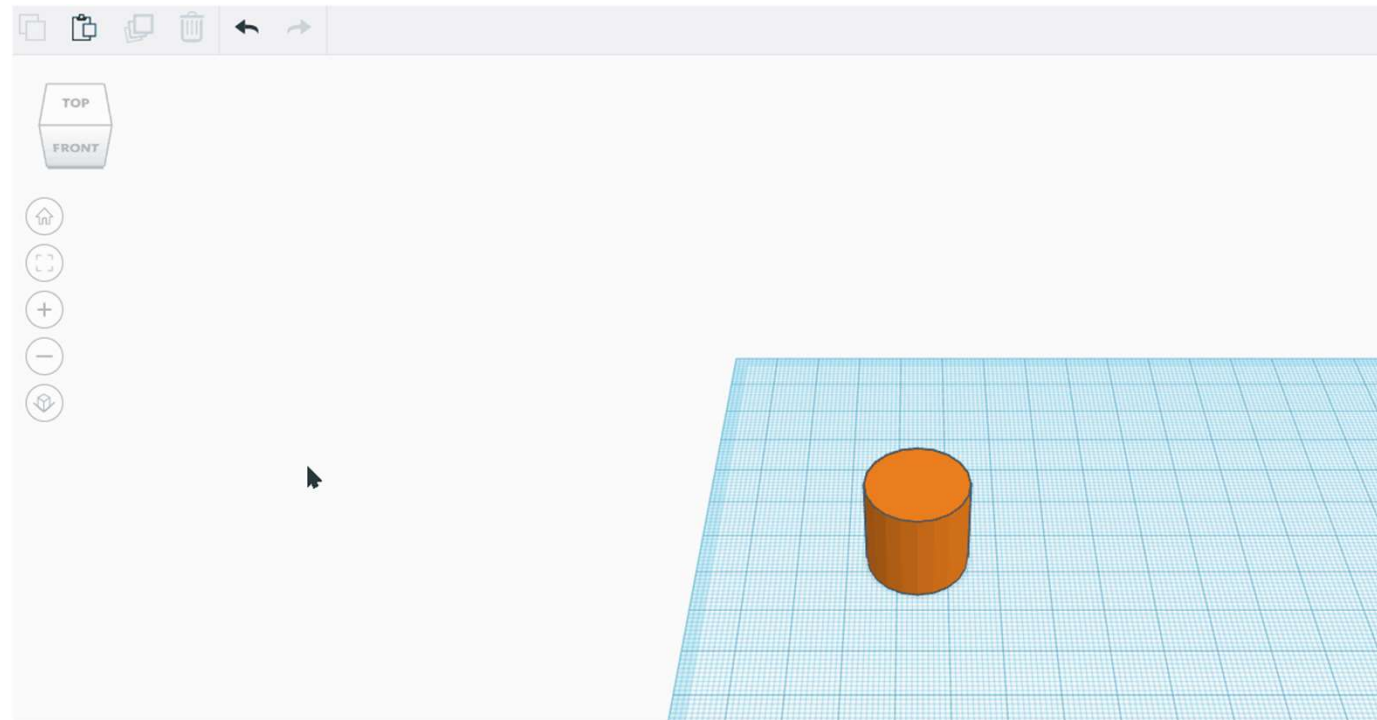
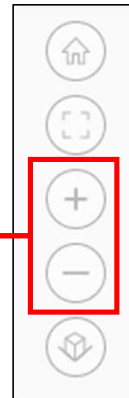



Autodesk TinkerCad

TinkerCad interface

Orthographic
or Perspective
view

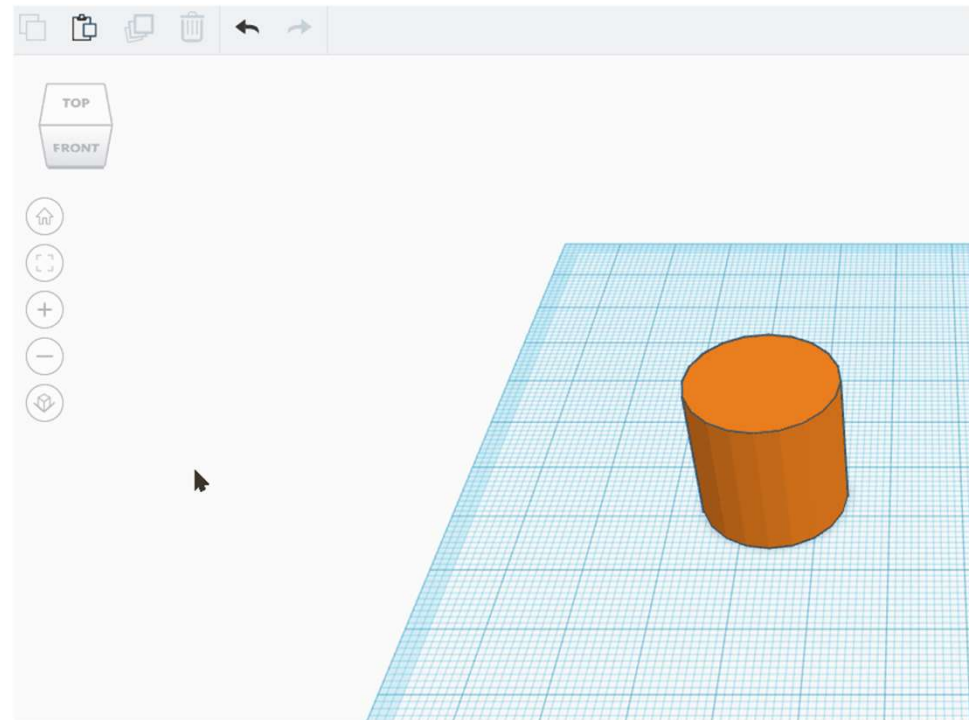

Autodesk TinkerCad

TinkerCad interface

Command Row

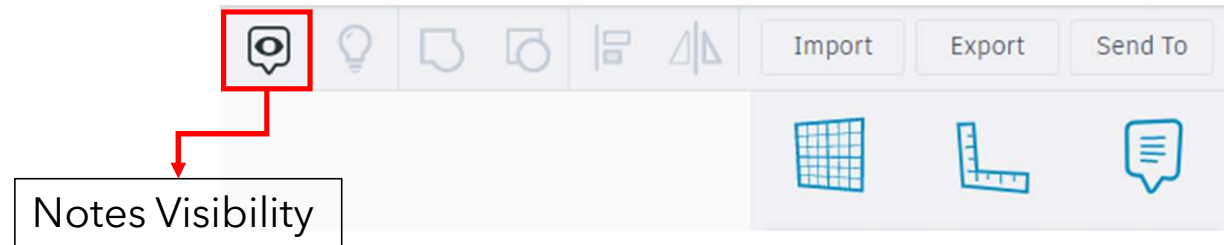

Autodesk TinkerCad

TinkerCad interface

Command Row

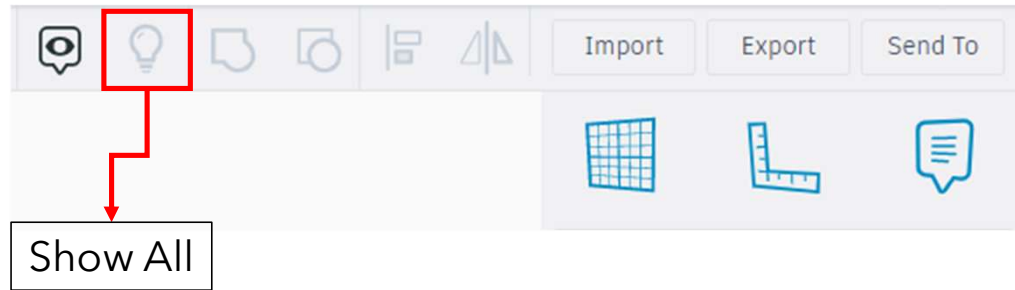

Autodesk TinkerCad

TinkerCad interface

Command Row

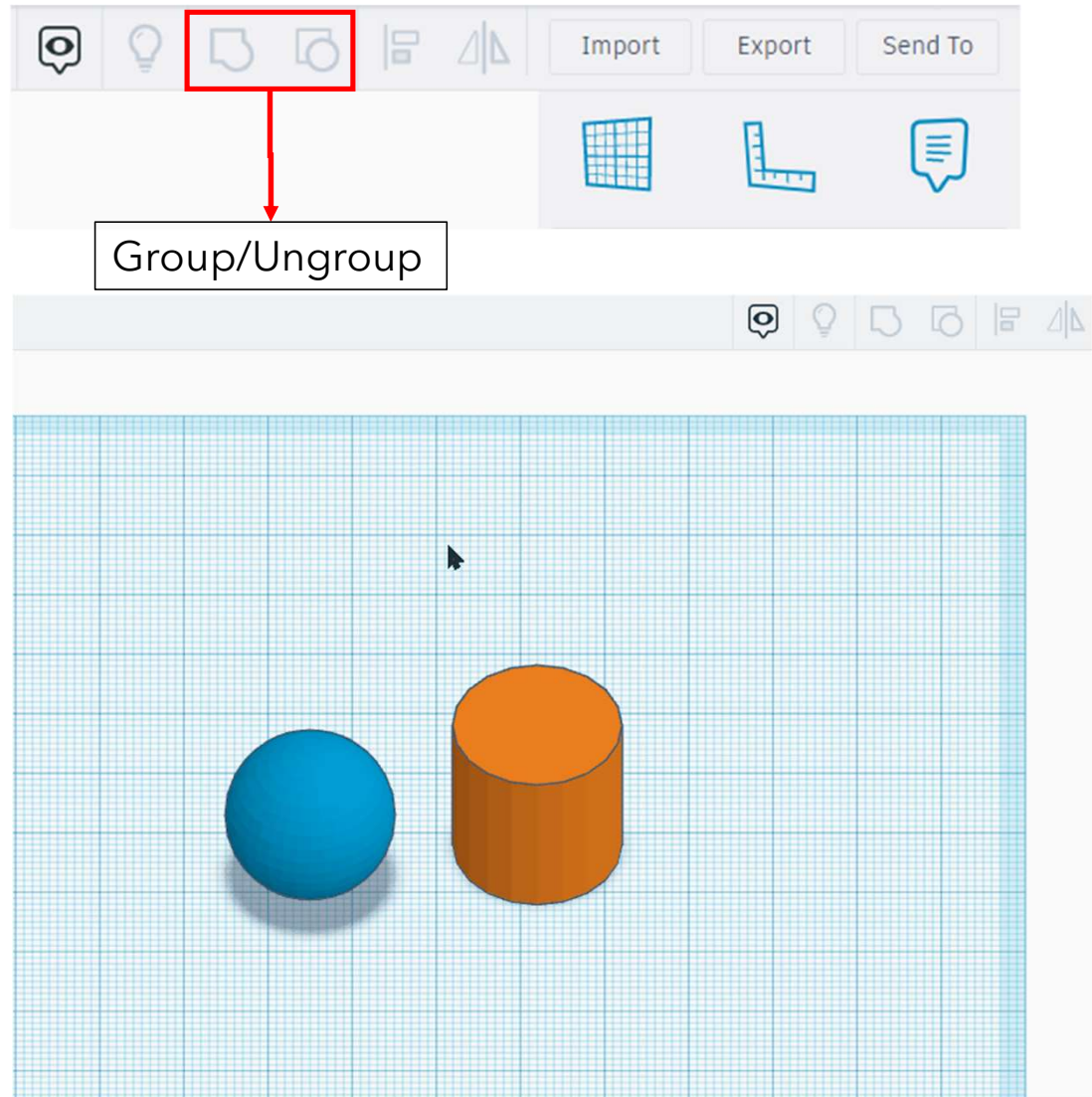

Autodesk TinkerCad

TinkerCad interface

Command Row

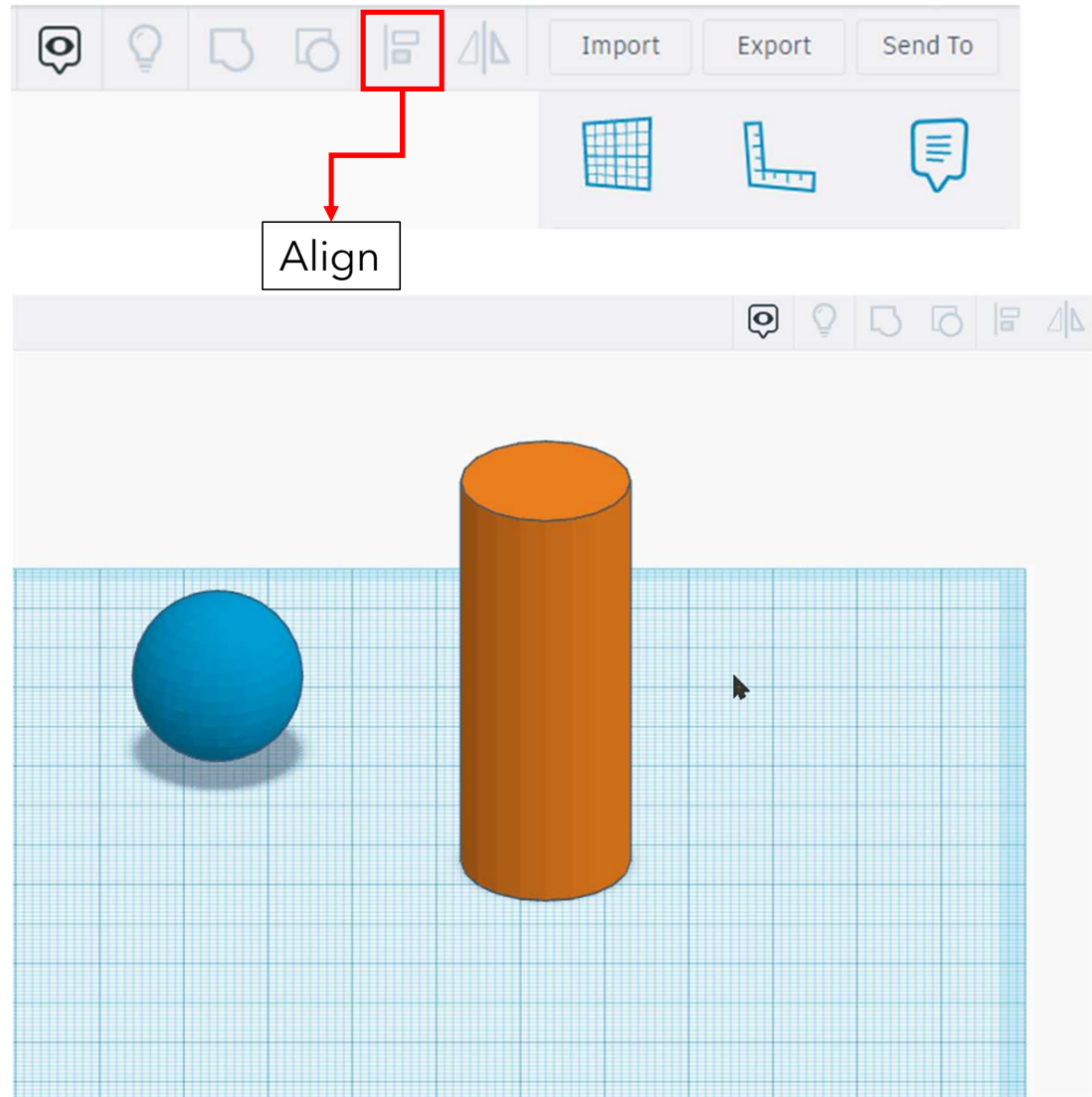

Autodesk TinkerCad

TinkerCad interface

Command Row

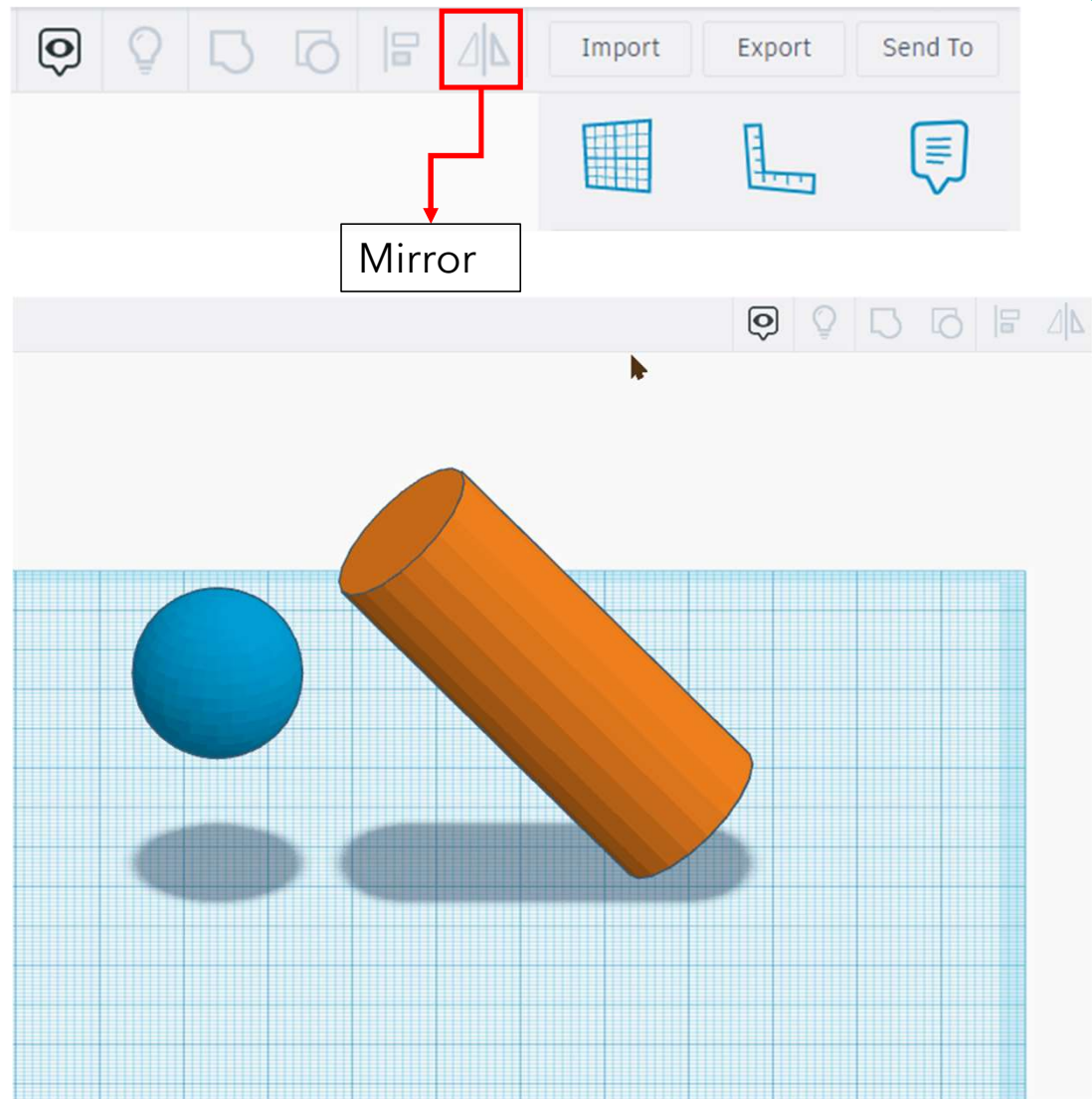

Autodesk TinkerCad

TinkerCad interface

Command Row

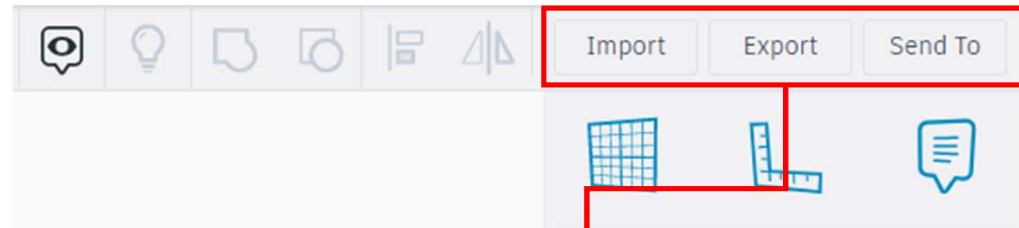

Import/Export/Send To

Autodesk TinkerCad

TinkerCad interface

Command Row

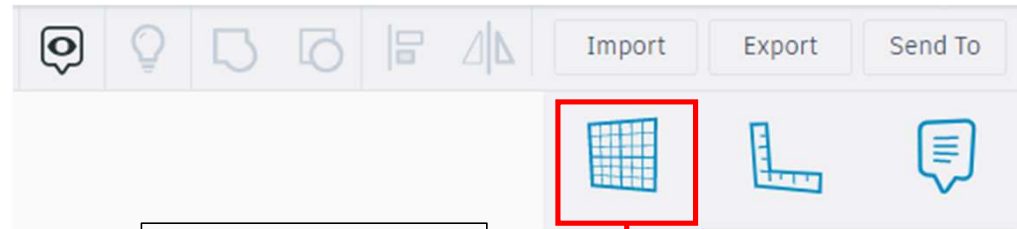

Workplane Tool

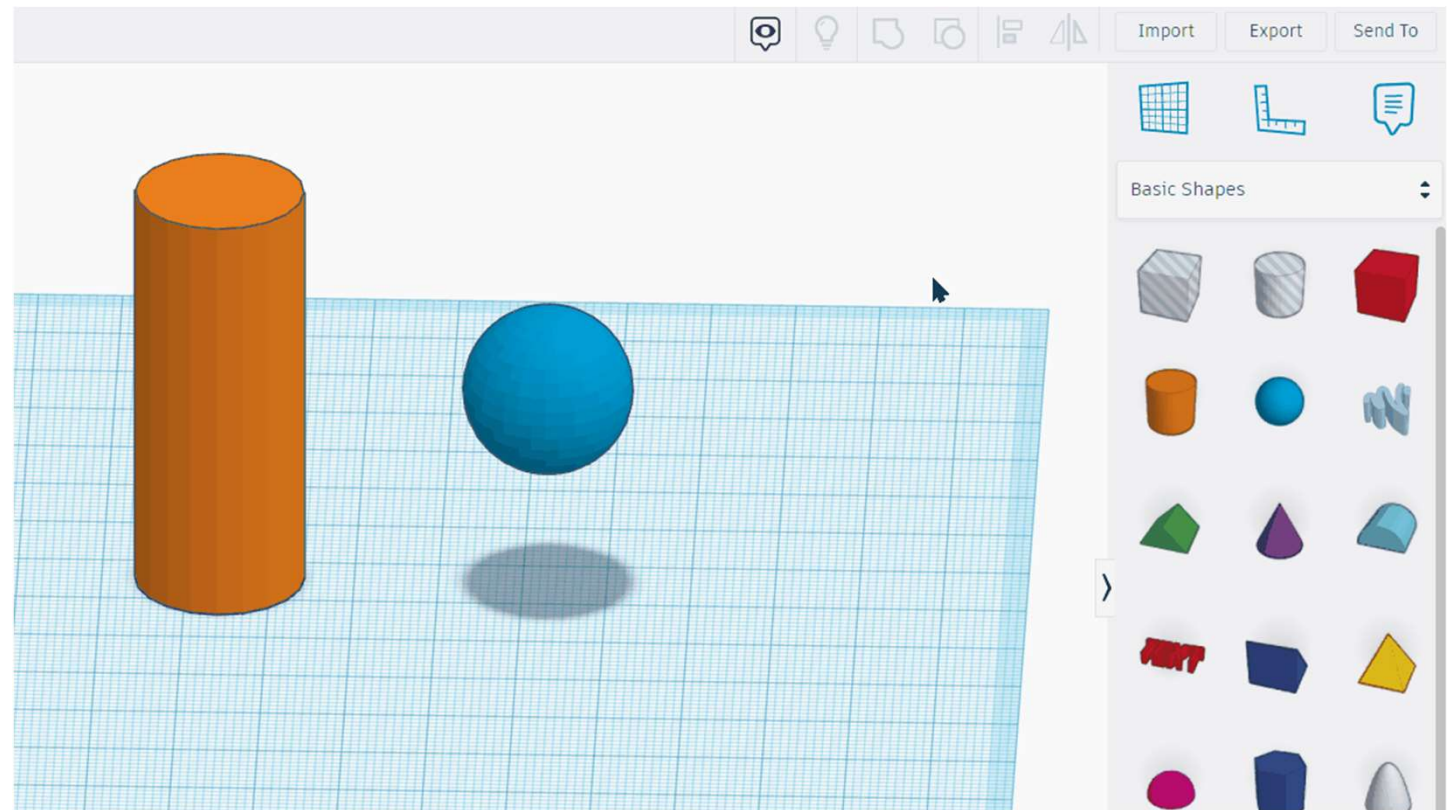

Autodesk TinkerCad

TinkerCad interface

Command Row

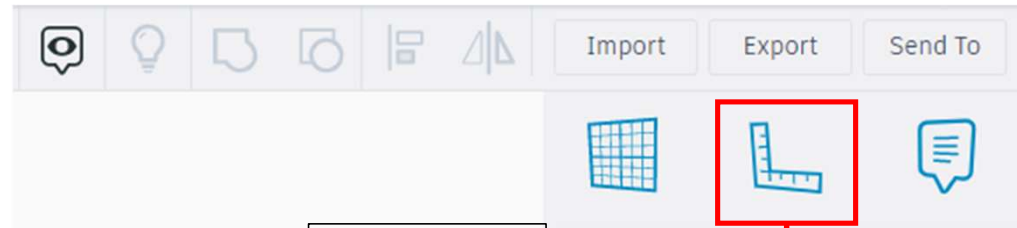

Ruler Tool

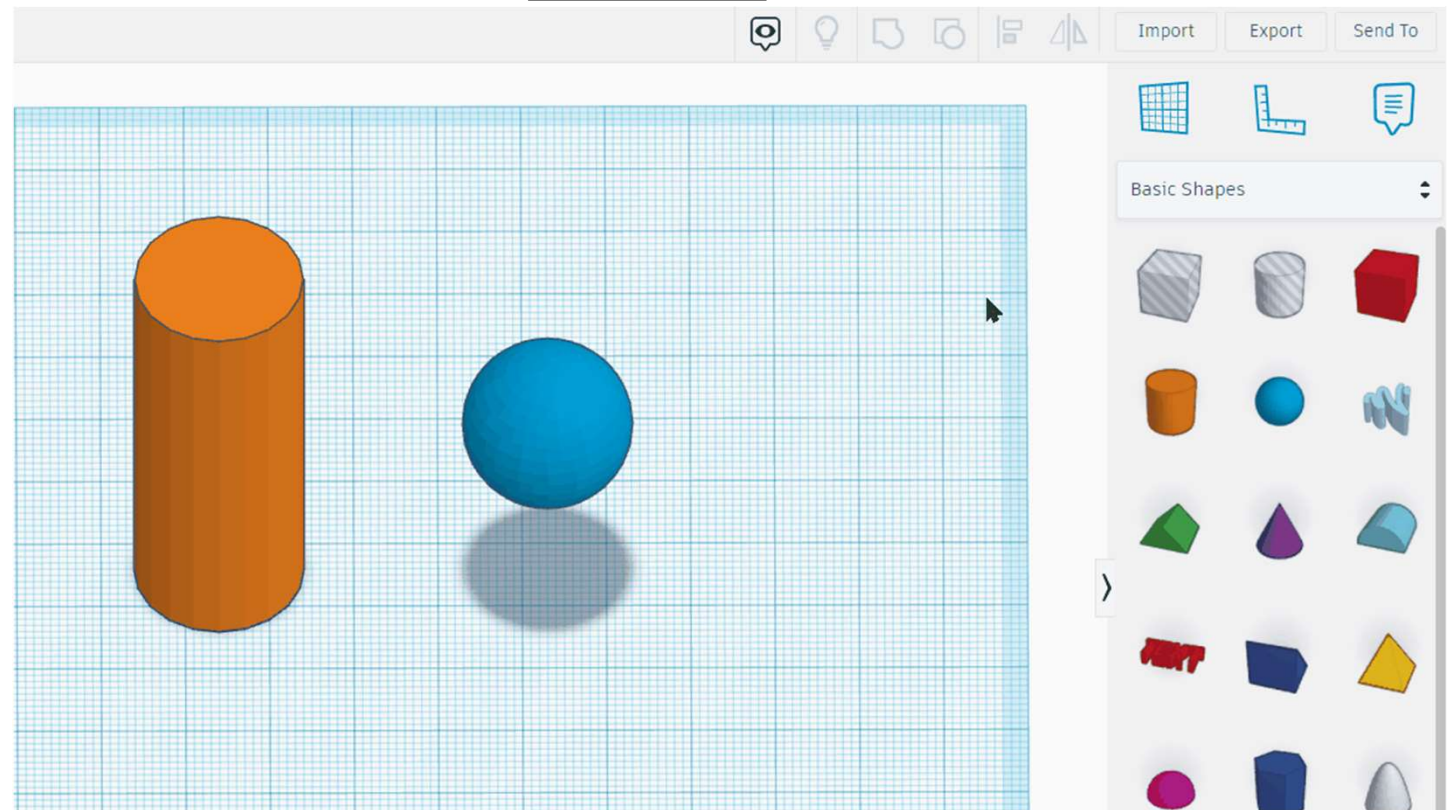

Autodesk TinkerCad

TinkerCad interface

Command Row

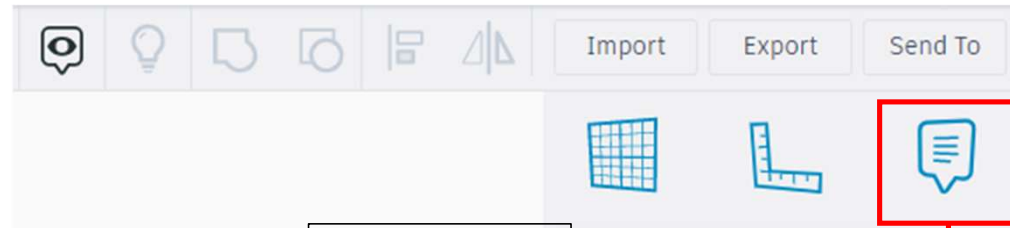

Notes Tool

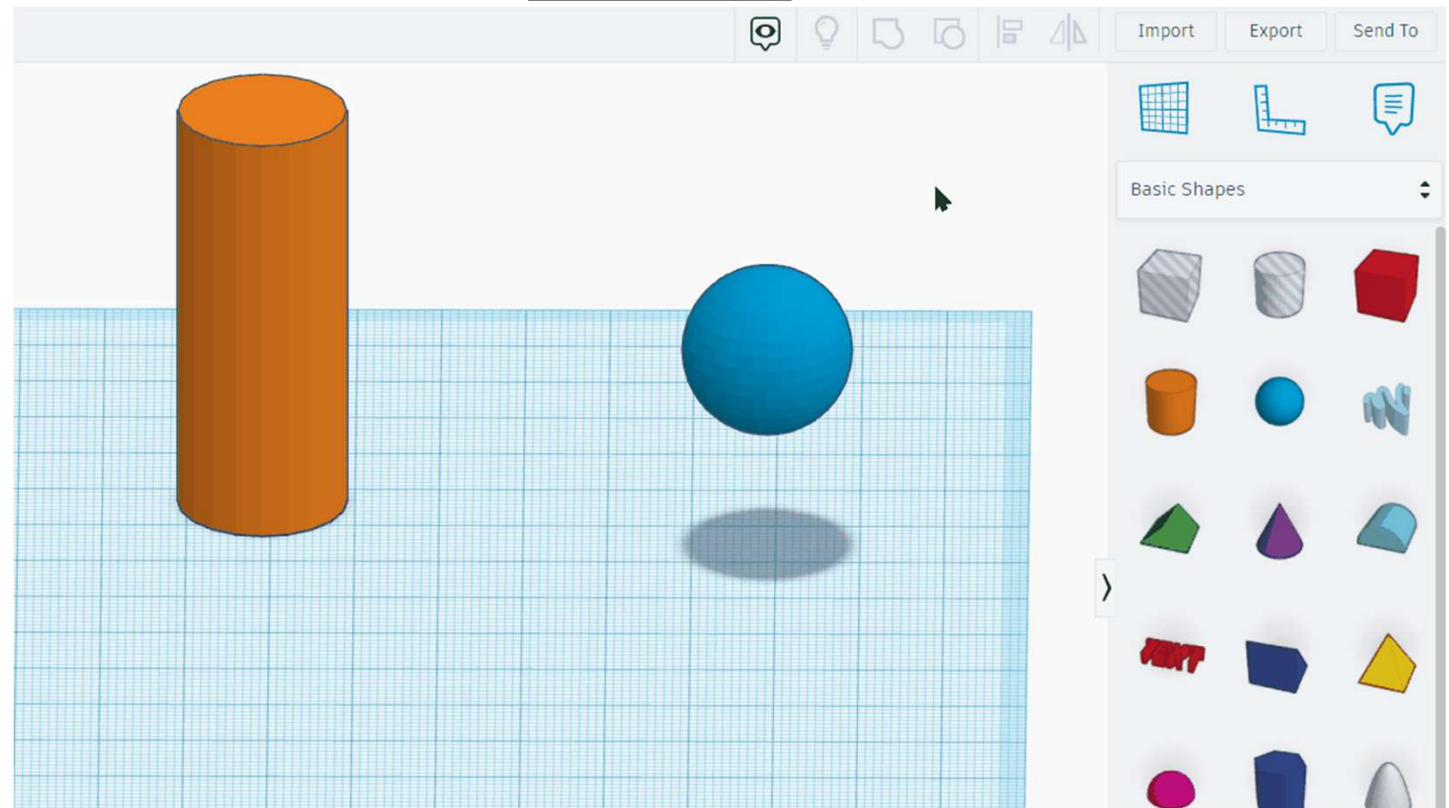



Autodesk TinkerCad

TinkerCad interface

Shapes

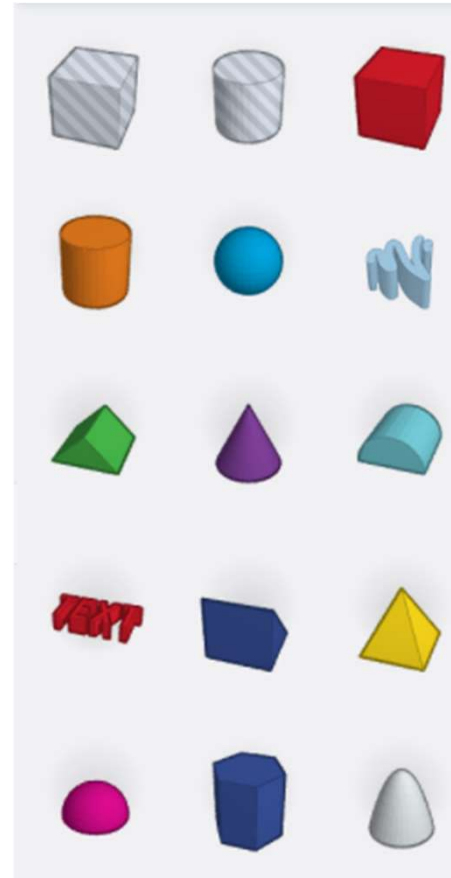



Autodesk TinkerCad

TinkerCad interface

Shapes

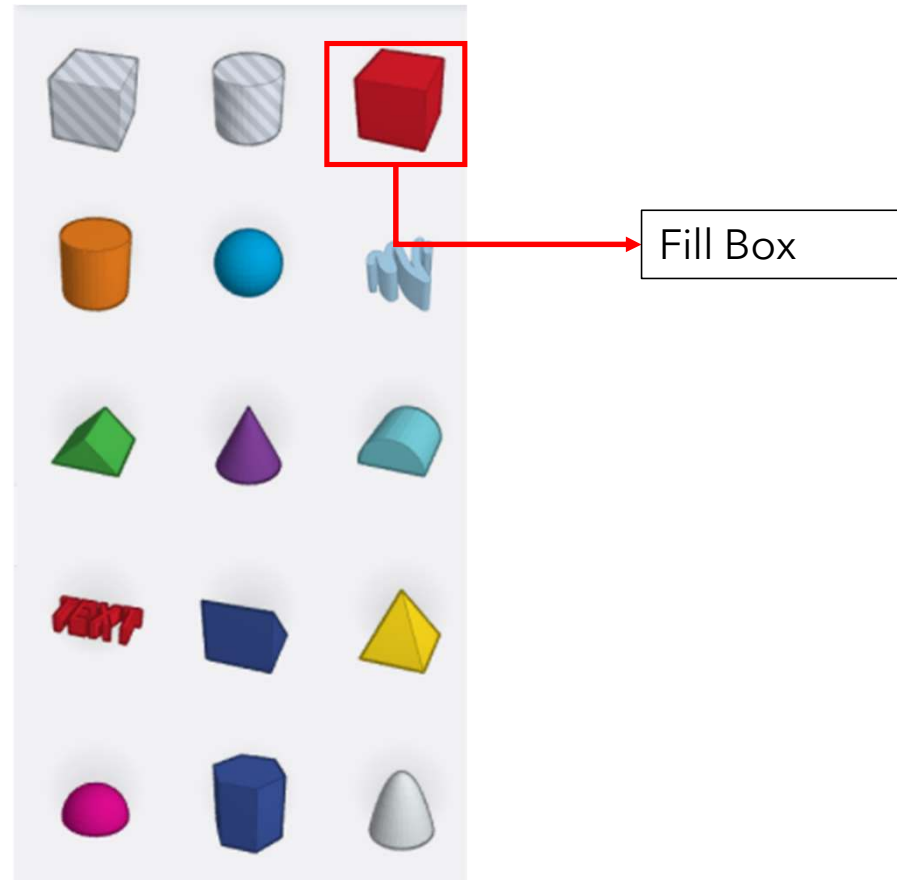



Autodesk TinkerCad

TinkerCad interface

Shapes

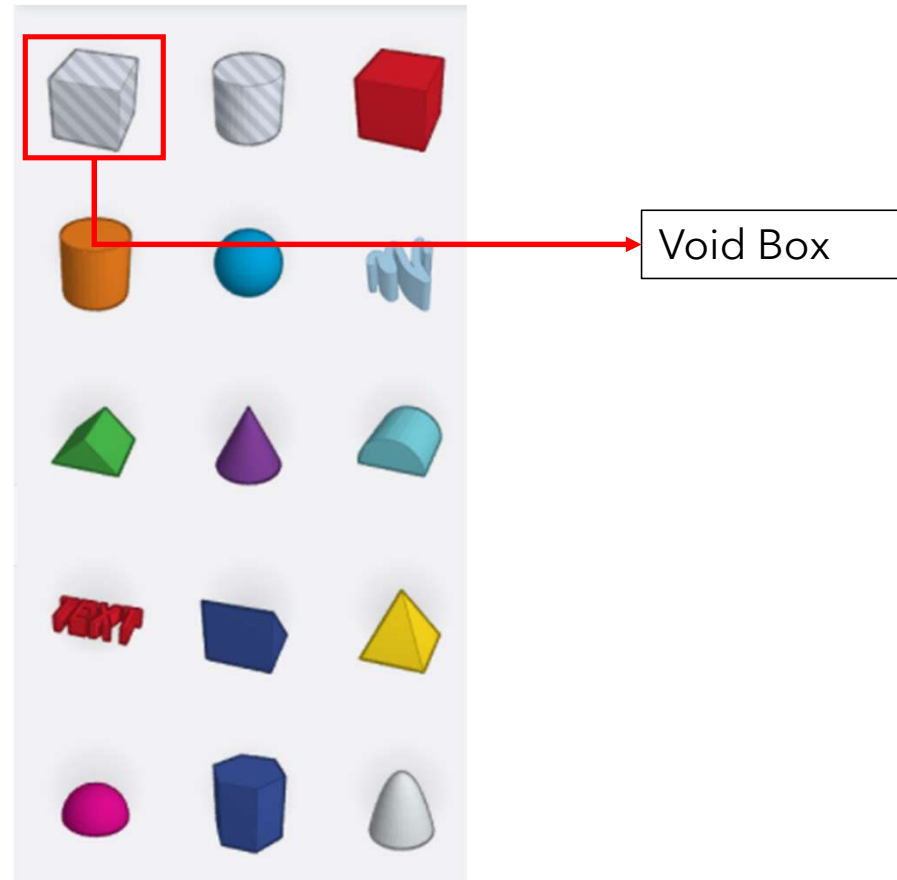



Autodesk TinkerCad

TinkerCad interface

Shapes

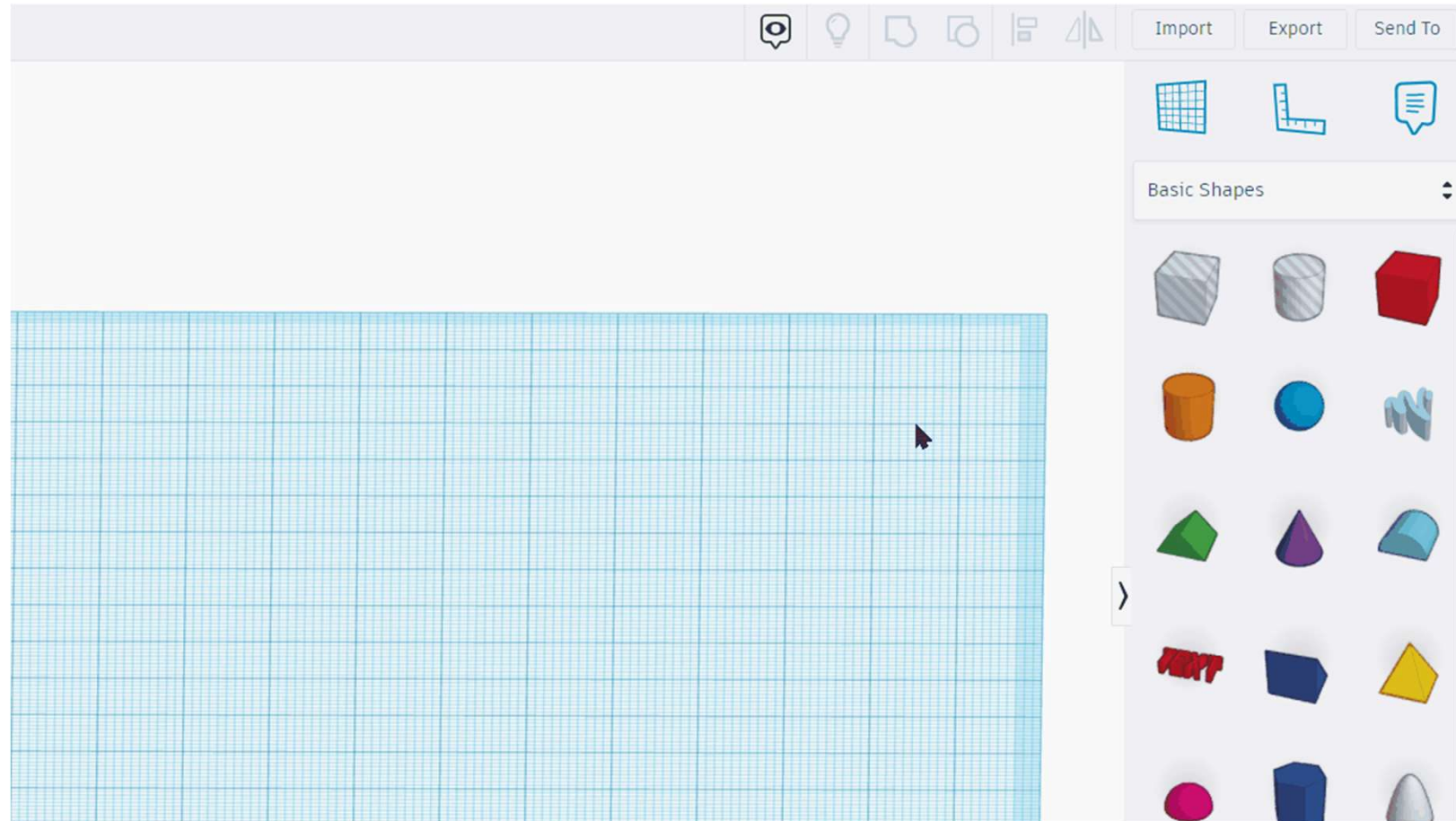



Autodesk TinkerCad

TinkerCad interface

Shapes

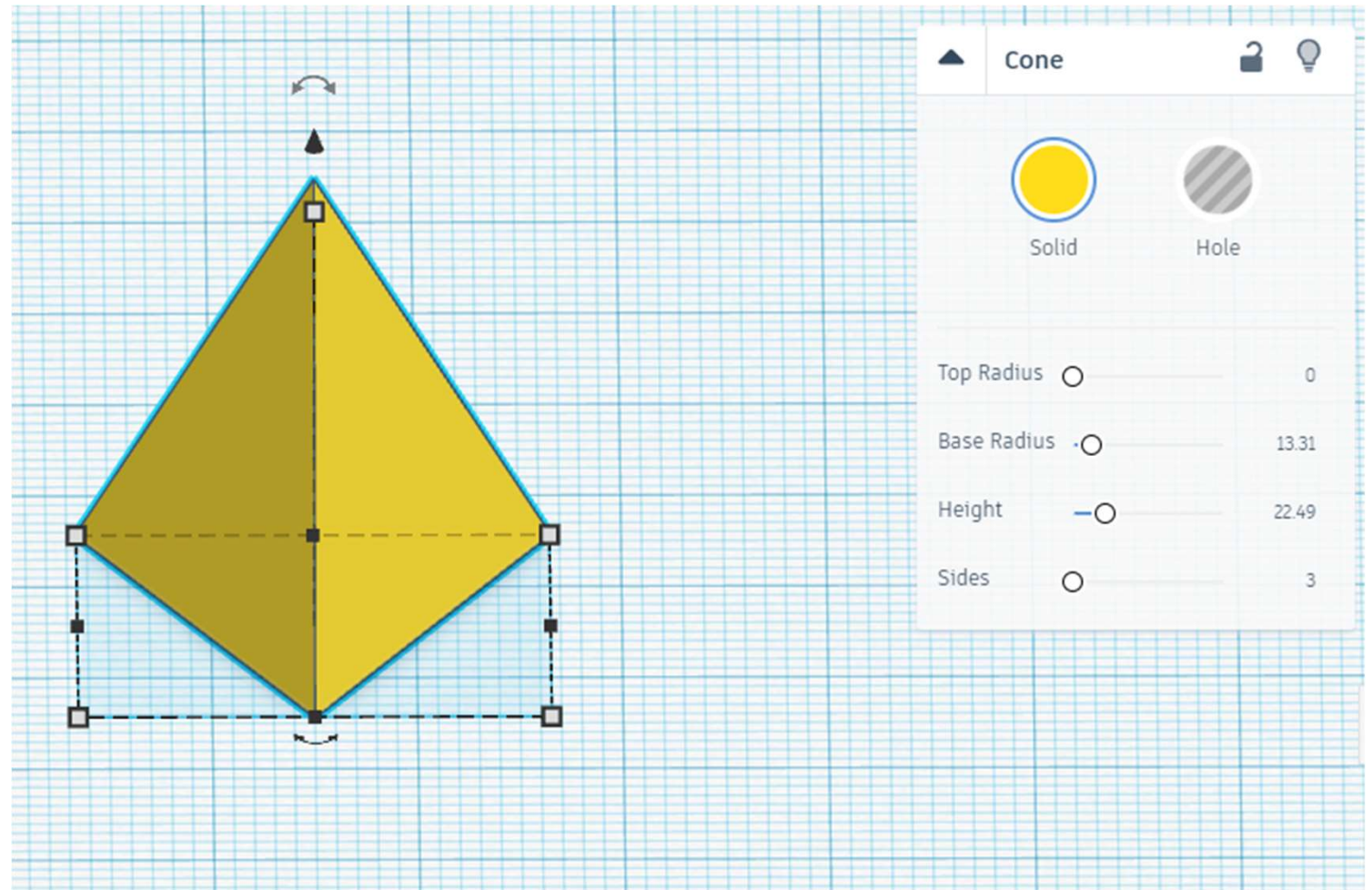



Autodesk TinkerCad

TinkerCad interface

Shapes

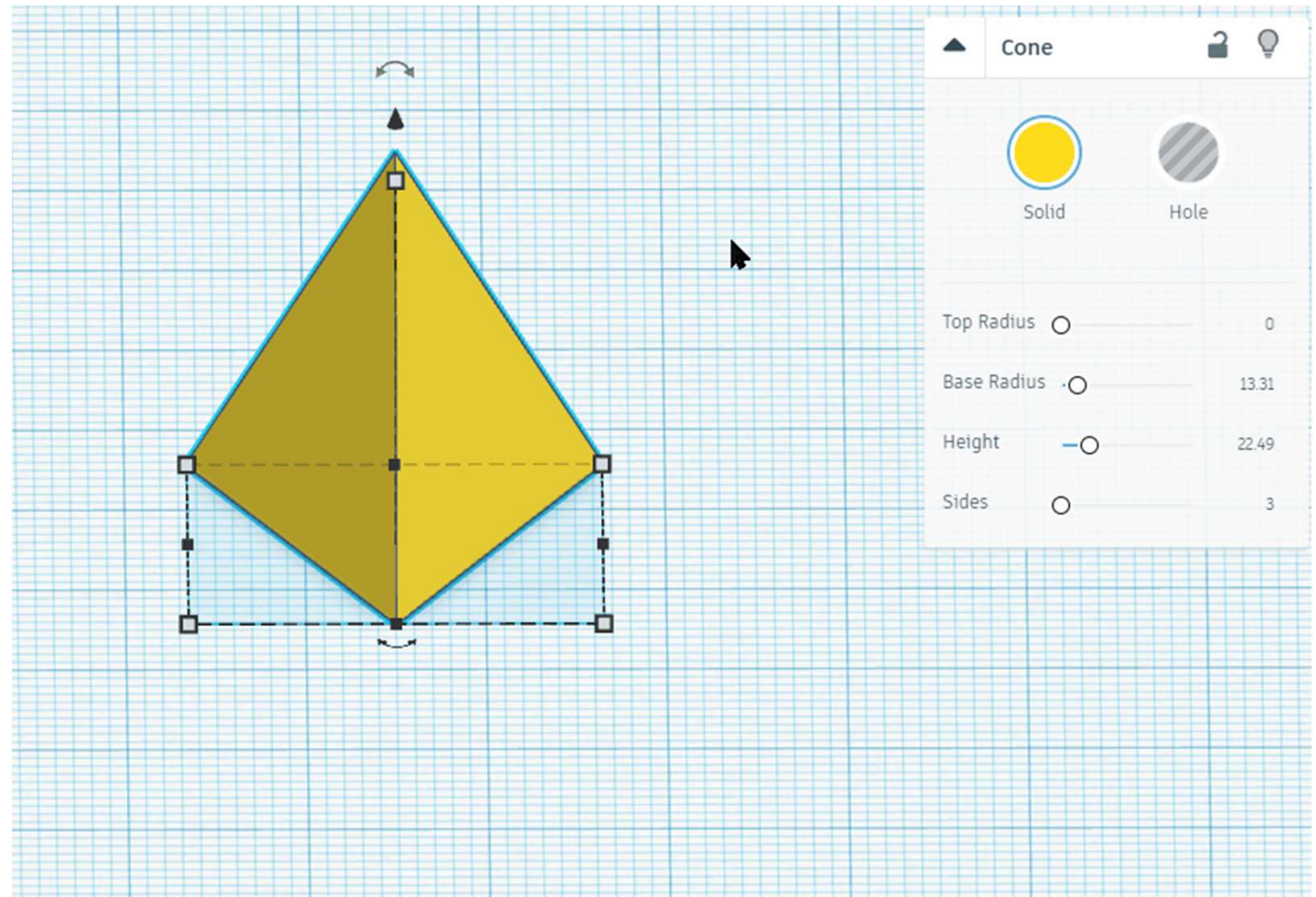



Autodesk TinkerCad

TinkerCad interface

Shapes

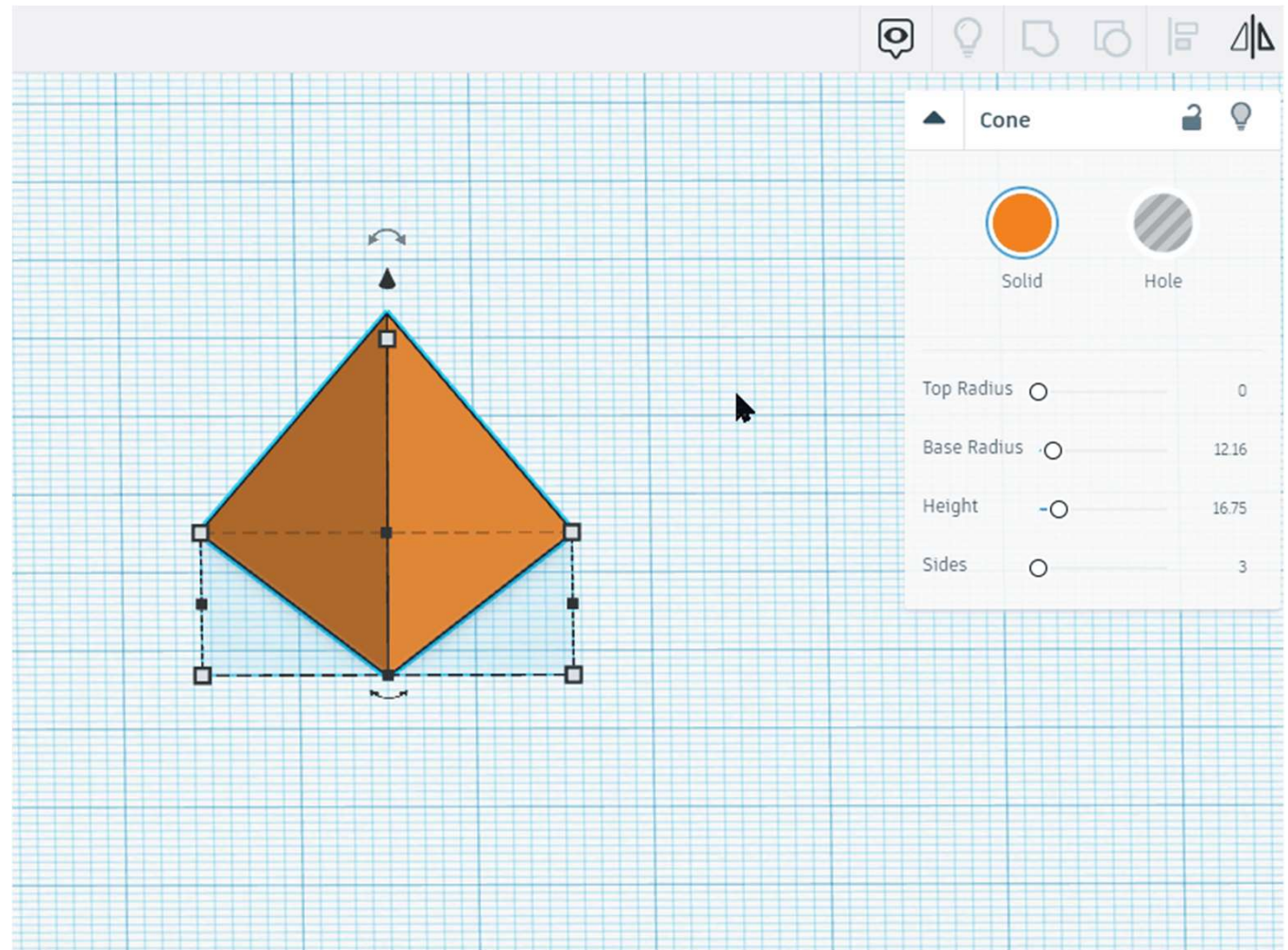



Autodesk TinkerCad

TinkerCad interface

Shapes Manipulation

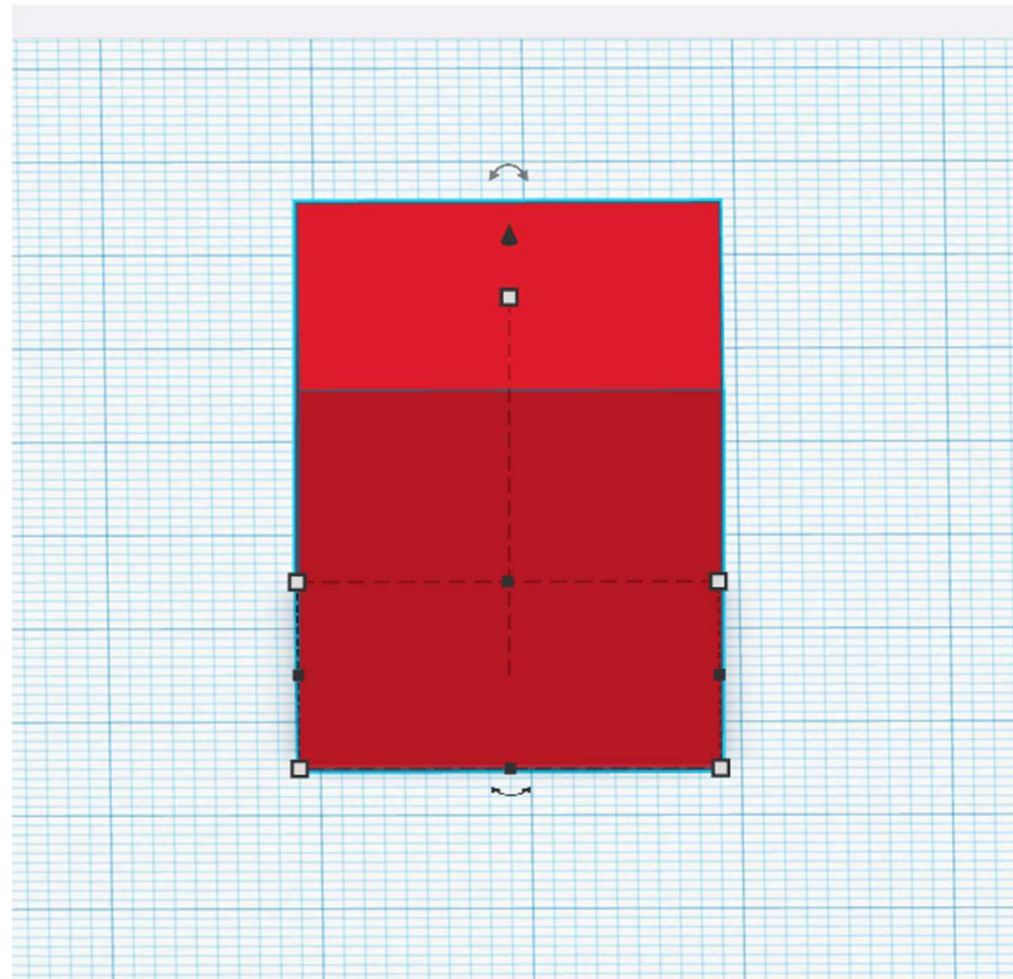



Autodesk TinkerCad

TinkerCad interface

Shapes Manipulation

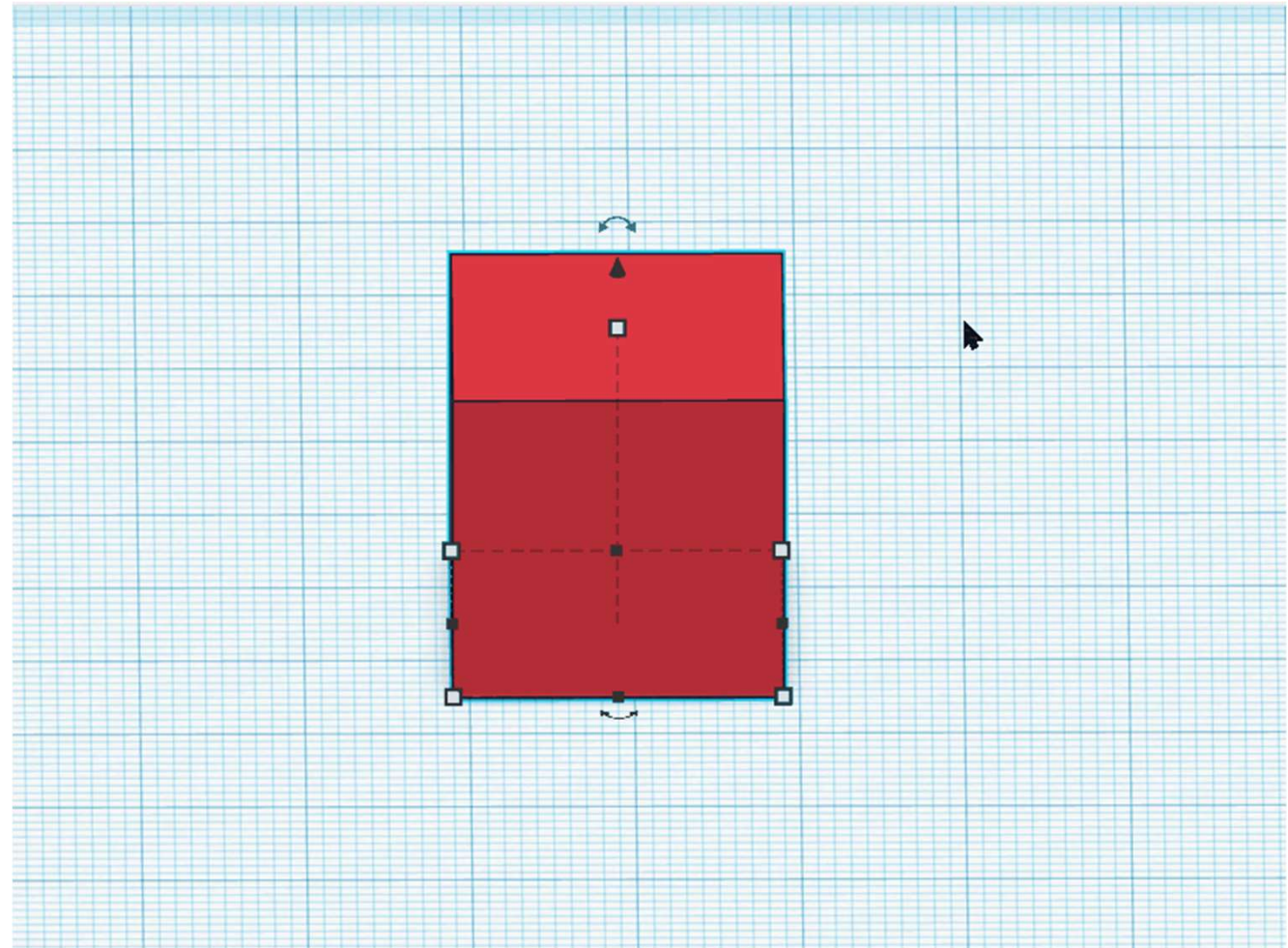



Autodesk TinkerCad

TinkerCad interface

Shapes Rotation

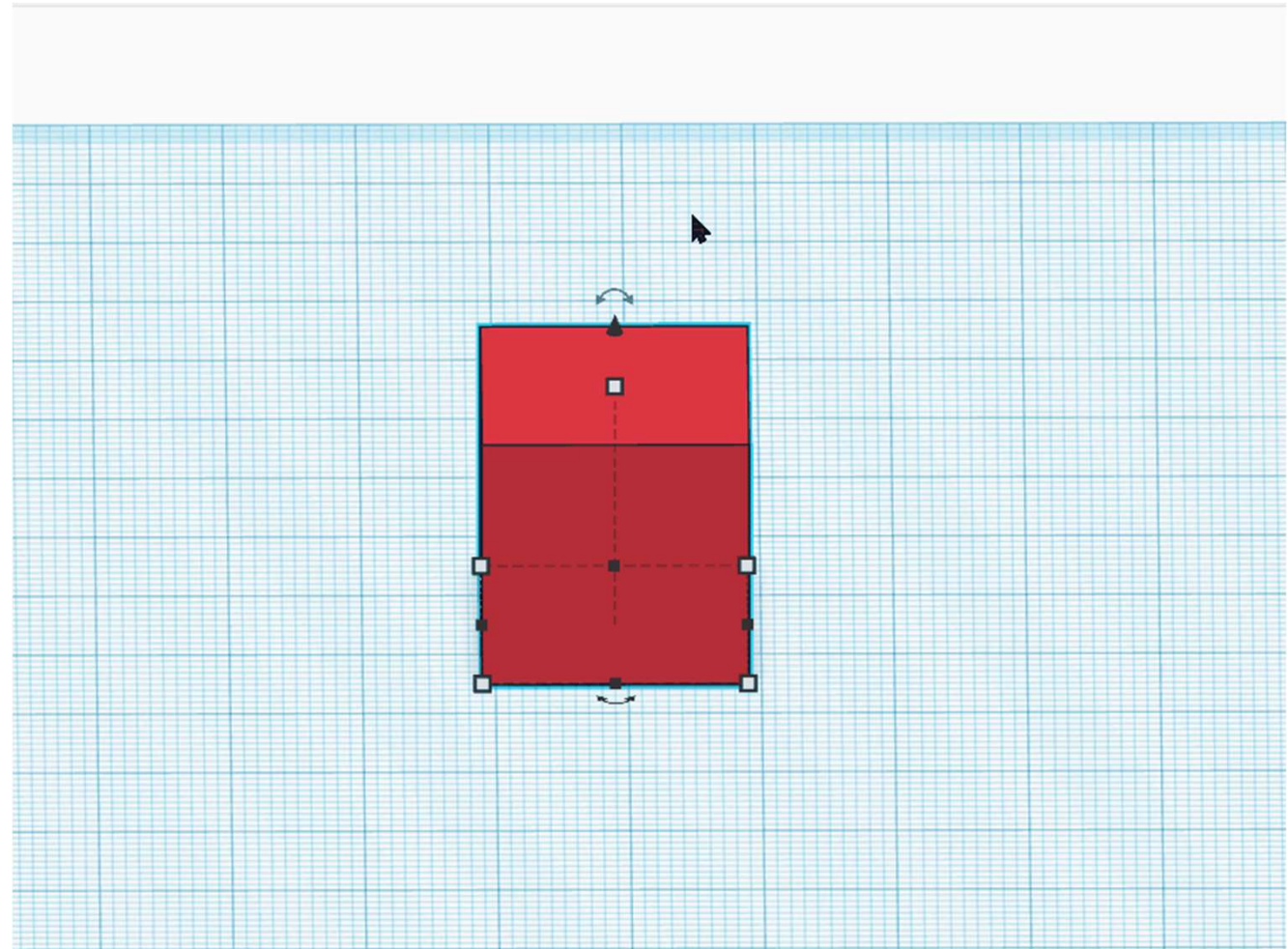



Autodesk TinkerCad

TinkerCad interface

Grid settings

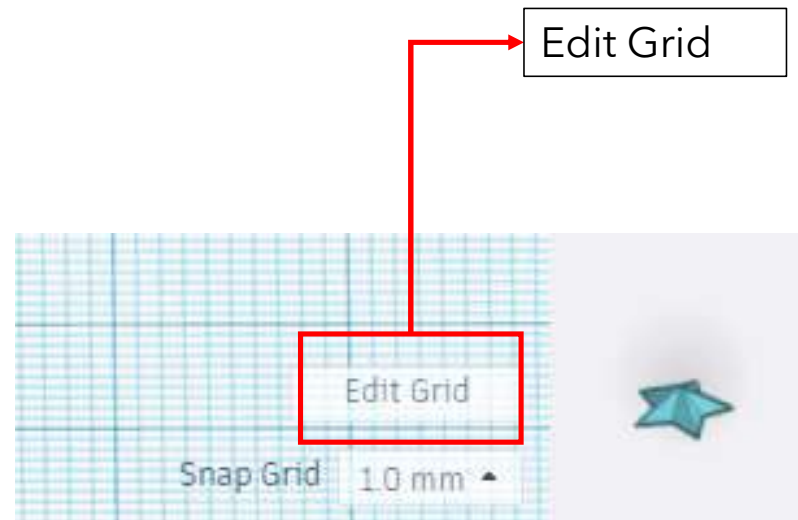



Autodesk TinkerCad

TinkerCad interface

Grid settings

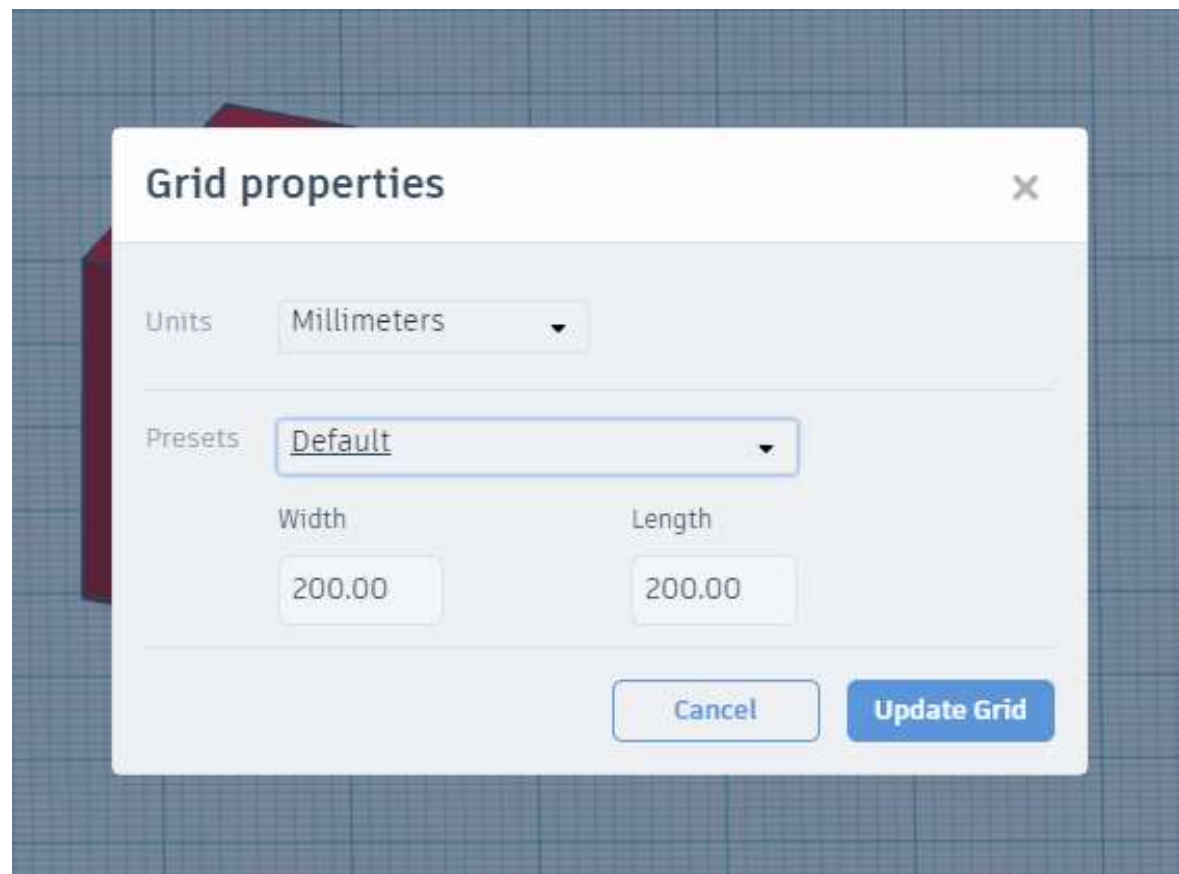



Autodesk TinkerCad

TinkerCad interface

Grid settings

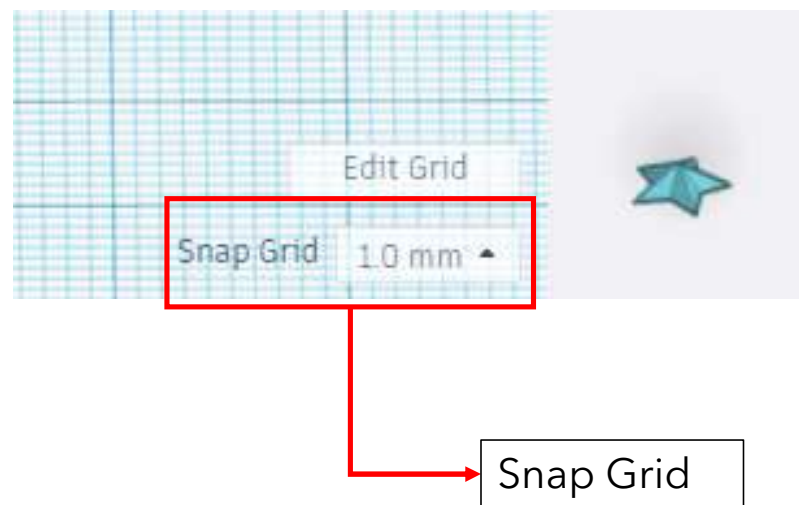



Autodesk TinkerCad

TinkerCad interface

Grid settings

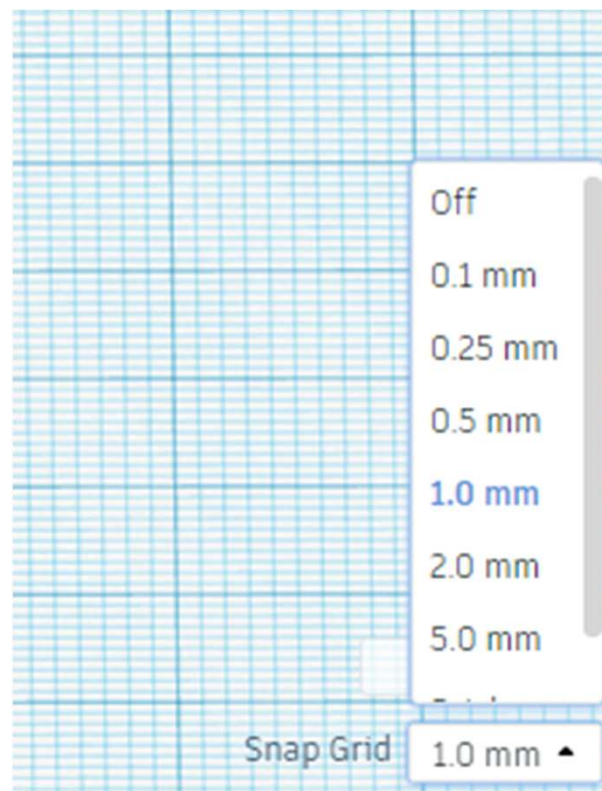

Autodesk TinkerCad

TinkerCad interface

3D Cooperative

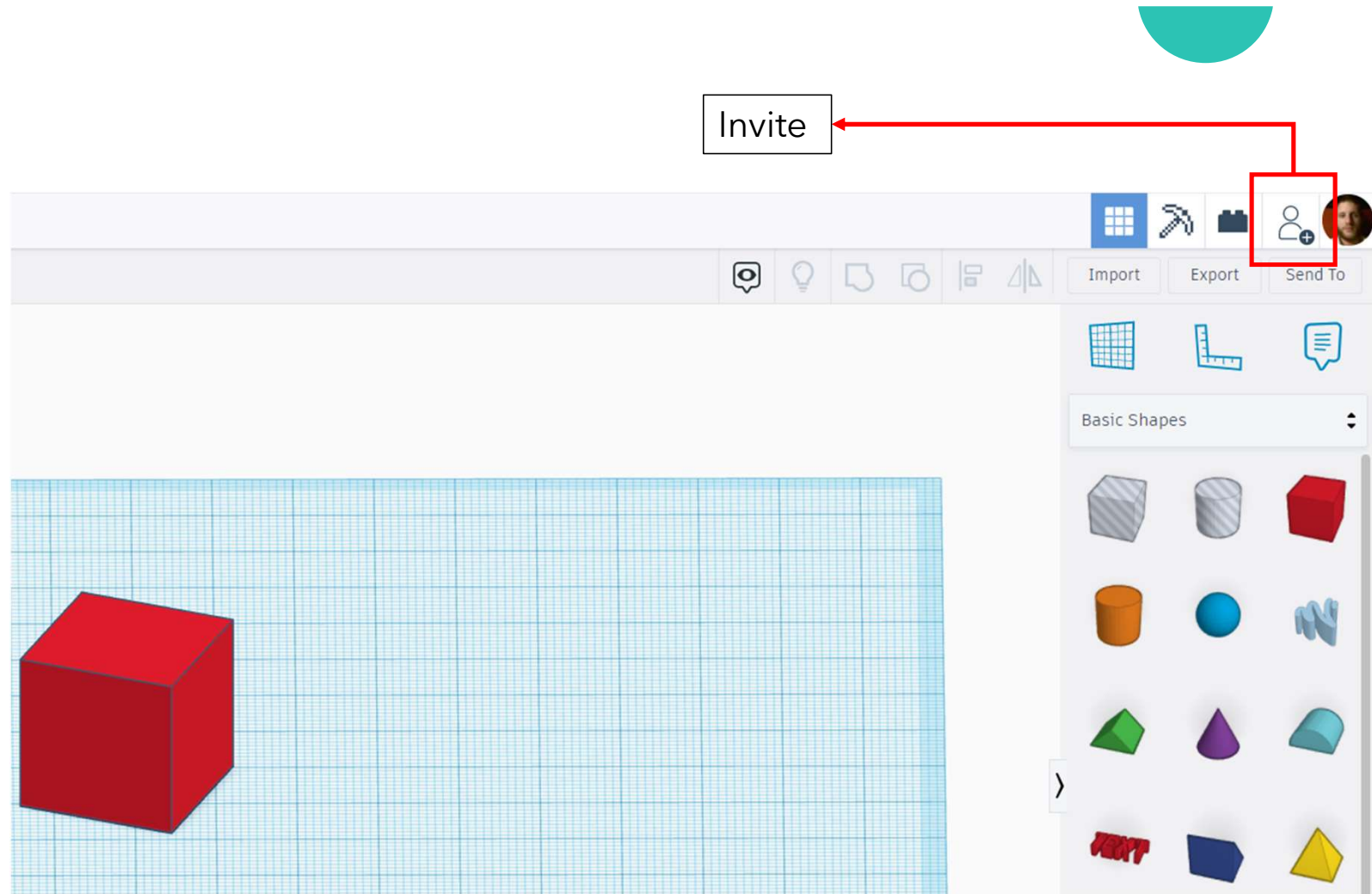



Autodesk TinkerCad

TinkerCad interface

3D Cooperative

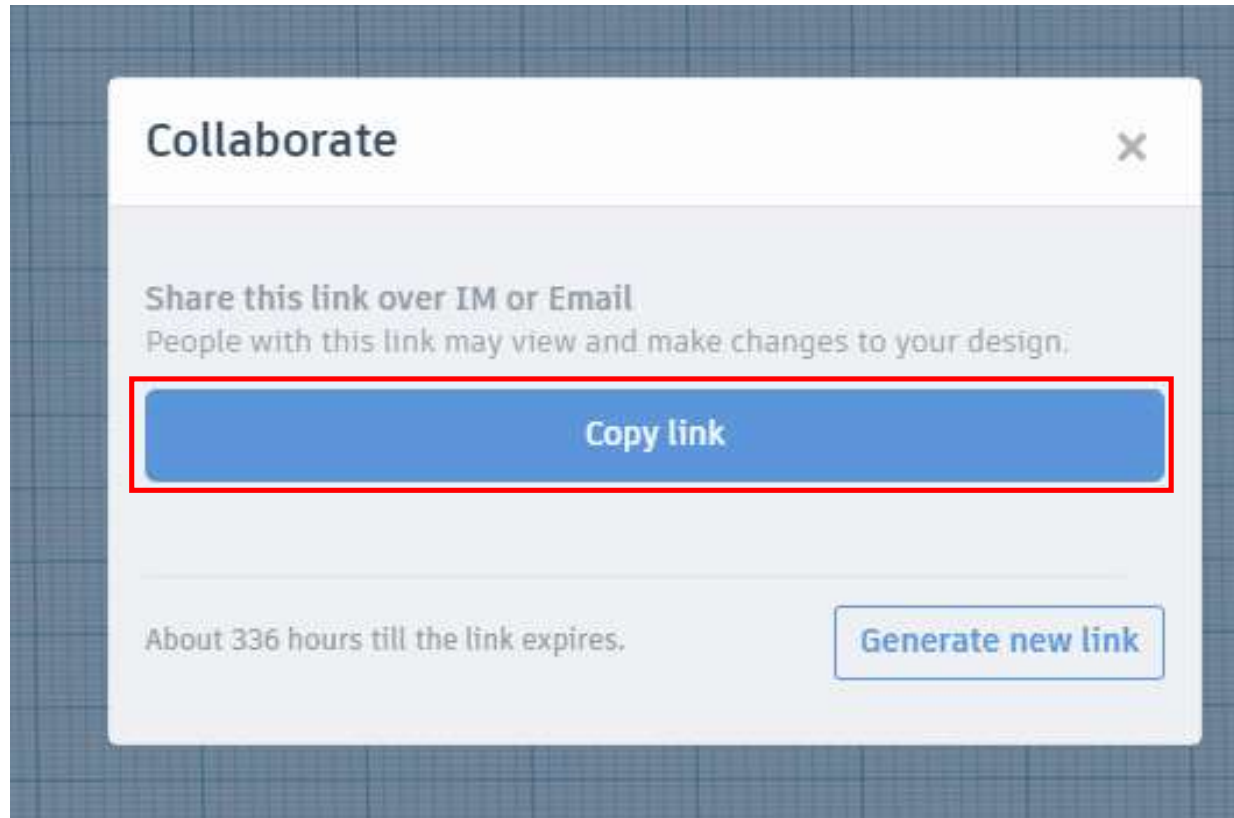



Practice!

To use TinkerCad you have to free register at **tinkercad.com**

Once you've done, you'll be redirect on your dashboard.

Click on "Create New Design" and....have Fun!



Thank you
very much for
your attention

Elia Schoen

29/09/2021

3D Drawing

76